

# Chapter 7

## PAVEMENT MARKING

<b>TABLE OF CONTENTS</b>	<b>Page</b>
7-1.00 INTRODUCTION .....	7-3
1.01 Purpose	
1.02 Scope	
1.03 Chapter Organization	
7-2.00 GLOSSARY .....	7-3
7-3.00 LEGALITY .....	7-4
3.01 Legal Authority	
3.02 Responsibility for Placement and Removal	
3.03 Legal Effect	
7-4.00 PAVEMENT MARKINGS .....	7-5
4.01 Materials	
4.02 Standards and Specifications	
4.03 Application Guidelines	
4.04 No-Passing Zone Surveys	
4.05 Standard Spotting Procedure	
4.06 Special Markings	
7-5.00 OBJECT MARKINGS .....	7-18
5.01 Purpose	
5.02 Types of Object Markers	
5.03 Applications and Guidelines	
7-6.00 DELINEATION .....	7-21
6.01 Types and Materials	
6.02 Delineator Location	
6.03 Deer Reflectors	
7-7.00 REFERENCES .....	7-22

## List of Figures

<b>Figure</b>	<b>Description</b>	<b>Page</b>
7.1	Two-Lane, Two-Way Roadway Pavement Marking Details . . . . .	7-23
7.2	Multi-lane Undivided Roadway Pavement Marking Details . . . . .	7-24
7.3	Two-Way Left Turn Lane Pavement Marking Details . . . . .	7-25
7.4	Passing Lane Section Pavement Markings . . . . .	7-26
7.5A	Major Intersection Pavement Markings . . . . .	7-27
7.5B	Major Intersection Pavement Markings . . . . .	7-28
7.6	Ramp and Through Lane Pavement Markings . . . . .	7-29
7.7	Exit Ramp on Curved Roadway Pavement Markings . . . . .	7-30
7.8	Removed	
7.8A	Auxiliary Lane Pavement Markings . . . . .	7-31
7.8B	Auxiliary Lane Pavement Markings . . . . .	7-32
7.9	Turn Lane & Left Turn Island Pavement Markings . . . . .	7-33
7.10	Bypass Lane Pavement Markings . . . . .	7-34
7.11	Divided Roadway Transition Pavement Markings . . . . .	7-35
7.12	Undivided Roadway Transition Pavement Markings . . . . .	7-36
7.13	Truck Climbing Lane Pavement Markings . . . . .	7-37
7.14	Railroad Crossing with Truck Stopping Lane Pavement Markings . . . . .	7-38
7.15	Free Right Turn Lane Pavement Markings . . . . .	7-49
7.16	No Passing Zone - Survey Procedure for a Vertical Curve . . . . .	7-40
7.17	Removed	
7.18	Spotting Symbols for Pavement Striping . . . . .	7-41
7.19	Pedestrian Crosswalk Markings . . . . .	7-42
7.20	Pedestrian Crosswalk Markings - Zebra Design . . . . .	7-43
7.21	School Zone Markings - Unsignalized Intersection . . . . .	7-44
7.22	Stop Ahead & Stop Line Pavement Markings . . . . .	7-45
7.23A	Parking Area Pavement Markings - Disabled Parking Details . . . . .	7-46
7.23B	Parking Area Pavement Markings - Disabled Parking Details . . . . .	7-47
7.23C	Parking Area Pavement Markings - Parking Stall Details . . . . .	7-48
7.23D	Parking Area Pavement Markings - Truck Parking Stall Details . . . . .	7-49
7.24	Airplane Pavement Markings . . . . .	7-50
7.25	High Occupancy Vehicle (HOV) Pavement Markings . . . . .	7-51
7.26	Commonly Used Object Markers . . . . .	7-52
7.27	Narrow Bridge Signing & Delineation . . . . .	7-53
7.28	One-Lane Bridge Signing & Delineation . . . . .	7-54
7.29	Unprotected Large Culvert & Cattle Pass Delineation . . . . .	7-55
7.30	Delineator Types & Installation . . . . .	7-56
7.31	Delineator Types & Installation . . . . .	7-57
7.32	Divided-Highway Intersection Delineation . . . . .	7-58
7.33	Diamond Interchange Delineation - Partial and Full Lighting . . . . .	7-59
7.34	Diamond Interchange Delineation - Unlit . . . . .	7-60
7.35	Cloverleaf Interchange Delineation - Full Lighting . . . . .	7-61
7.36	Roundabout Intersection Pavement Markings . . . . .	7-62

## List of Charts

<b>Chart</b>	<b>Description</b>	<b>Page</b>
7-1	Removed	
7-2	Minimum Length of a No Passing Zone in Advance of a Stop Condition . . . . .	7-63
7-3	Minimum Passing Sight Distance . . . . .	7-63
7-4	Minimum Distance or Gap Between No-Passing Zones . . . . .	7-63
7-5	Object Markers . . . . .	7-64
7-6	Delineator Fabrication Details . . . . .	7-65
7-7	Finding the Degree of Curve for a Horizontal Curve . . . . .	7-66
7-8	Crosswalk Warrants . . . . .	7-67

## CHAPTER 7 - PAVEMENT MARKINGS

### 7-1.00 INTRODUCTION

#### 7-1.01 Purpose

It is MN/DOT's mission to provide appropriate pavement markings on all highways 365 days per year.

This chapter gives specific guidelines for the use of pavement markings. The Minnesota Manual on Uniform Traffic Control Devices (MN MUTCD), sets forth general standards, while this manual outlines preferred practices within the MN MUTCD standards.

#### 7-1.02 Scope

Standards for the application of markings and delineation are set forth in the MN MUTCD, and those basic principles must be followed by the engineers, technicians, and maintenance personnel responsible for the design, selection, placement, and documentation of these devices. The Traffic Engineering Manual (TEM) does not duplicate or violate the standards established in the MN MUTCD. The TEM presents the preferred practice in the application of pavement markings, object markers, and delineators. Information presented in this chapter includes: (1) types and use of materials, (2) general principles to be followed, (3) design details, including standards and specifications, and (4) the specific use of markings and delineation. Users of the TEM should be completely familiar with the current MN MUTCD requirements before attempting to apply the guidelines established in this chapter.

#### 7-1.03 Chapter Organization

Important terms used in this chapter are defined in the Glossary of the TEM. The remaining sections of the chapter discuss: (1) legality, (2) pavement markings, (3) special markings, (4) object markings, (5) delineation.

### 7-2.00 GLOSSARY

**Appropriate Pavement Marking** - One that meets or exceeds the standards defined in the MN MUTCD including any minimum levels of retroreflectivity, when weather permits. During winter operations, pavement markings should provide presence after bare pavements are attained.

**Centerline** - A line indicating the division of the roadway between traffic traveling in opposite directions.

**Channelizing Line** - A line which directs traffic and indicates that traffic should not cross the line.

**Continental Block** - White longitudinal lines placed at crosswalks that are parallel to the flow of traffic.

**Contrast Marking** - A marking placed alongside and/or on the ends of a light colored marking and/or within the whole groove for the light marking. Black may be used in combination with the light markings on concrete to enhance the visibility of the marking. The light marking is typically placed in the middle of the black contrast marking.

**Delineator** - A light-reflecting device mounted at the side of the roadway, in a series with others, to indicate the alignment of the roadway.

**Durable Markings** - Marking materials designed to provide year round presence and retroreflectivity for at least two years.

**Edge Line** - A line which indicates the edge of the roadway.

**Hazardous Waste** - With respect to removal of pavement markings, waste debris created may be toxic (see Toxicity in Specified Products) and/or flammable and require handling and disposal procedures prescribed by waste management laws, rules, and regulations.

**Lane Line** - A line separating two lanes of traffic traveling in the same direction.

**Non-Hazardous Waste** - With respect to the removal of pavement markings, waste debris may be disposed of using less stringent criteria. This would make it acceptable at some in-state waste facilities as designated by the Office of Environmental Services.

**Object Markers** - Markings intended for use on obstructions within or adjacent to the roadway.

**Pavement Markings** - All lines, symbols, words, colors, or other devices, except signs and power-operated traffic control devices, set into the surface of, applied upon, or attached to the roadway.

**Roadway** - That portion of a highway used for vehicular travel, exclusive of the berm or shoulder. A divided highway includes two or more separate roadways.

**Sharks Teeth** - Triangular shaped markings placed at roundabout intersection as a yield line.

**Stop Line** - A line which indicates where vehicles should stop when directed to stop.

**Toxics in Specified Products** - Minnesota Statute 115A.9651 prohibits the use of toxic heavy metals in any ink, dye, pigment, paint, or fungicide after September 1, 1994. The prohibited toxic heavy metals are lead, cadmium, mercury, and hexavalent chromium. They may be found in older pavement markings, particularly lead and chromium in yellow markings. Consequently, non-toxic pavement markings must be specified in contracts and purchases.

**Waste Debris** - With respect to pavement marking materials, white or yellow-colored paint/bituminous or concrete mixtures generated by the removal of pavement markings.

## **7-3.0 LEGALITY**

### **7-3.01 Legal Authority**

Minnesota Statutes 169.06 (Subdivisions 1-4) and 169.07 establishes the legal authority for the Department and local units of government to: (1) place and maintain markings, (2) require obedience to official markings, (3) prohibit the display of unauthorized markings, and (4) prohibit interference with official markings. Markings shall be placed only by the authority of the public body having jurisdiction over the highway, road, or street for the purpose of regulating, warning, or guiding traffic. Pavement and curb markings, object markers, and delineators are all normally within highway, road, or street rights-of-way and, therefore, should never be installed except under public authority.

Two 1990 Session Laws, Chapters 482 and 497, modified handicapped parking requirements for the disabled.

### **7-3.02 Responsibility for Placement and Removal**

Permanent pavement markings are the responsibility of the governing road authority. These markings may be placed or removed by maintenance personnel or contractor

### **7-3.03 Legal Effect**

Minnesota Statutes, Section 169.18, refers to specific distinctive pavement markings which prohibit the driver from making specified maneuvers or guide the driver in certain paths.

It is important that correct markings are used since markings have specific meanings defined in the law. The use of inappropriate markings and delineators could lead to legal claims of negligence.

## 7-4.0 PAVEMENT MARKINGS

### 7-4.01 Materials

The basic requirements for pavement markings are: (1) specified colors are identifiable day and night and (2) minimum visibility standards are maintained throughout the material's lifetime. Factors considered in selecting markings are durability, workability, drying and non-track time, accommodation of heavy traffic volumes, replacement of material, safety, and environmental concerns.

#### 7-4.01.01 Durable Markings

Experience has shown that traffic volumes and resulting snow and ice operations have the greatest impact on the performance of pavement markings. The following chart outlines the life expectancy of various materials based on traffic volumes.

Material	Average Daily Traffic	
	< 1500	> 1500
Latex Paint	> 1 year	1 year
Epoxy (Plural component Liquid)	> 5 years	3-5 years
Preformed Polymer Tape	>5 years	>5 years

### Statewide Policy

To meet the goal of providing an appropriate marking 365 days per year, the following Policy for the application of pavement marking materials has been developed.

#### Multi-Lane Divided or Undivided Roadways

Remaining Pavement Surface Life <sup>1</sup> (years)	Edgeline	Centerline, Lane Line, and <sup>2</sup> Special Markings
0 - 2	Paint	Paint
2 - 6	Epoxy	Epoxy
6 +	Epoxy	Tape <sup>3</sup>

<sup>1</sup> Anticipated life of existing pavement is based on planned projects and anticipated life of surface is based on preventive maintenance plans.

<sup>2</sup> Special markings include transverse markings (i.e. stop bars and crosswalks), gore markings, and word and symbol markings.

<sup>3</sup> Preformed Polymer Tape shall utilize the inlaid method on both bituminous and concrete pavements (including bridge decks).

### Two-Lane, Two-Way Roadways

Remaining Pavement Surface Life <sup>1</sup> (years)	Edgeline	Centerline	Edgeline	Centerline
0 - 2	Paint	Paint	Paint	Paint
2 +	Paint	Paint	Epoxy	Epoxy

<sup>1</sup> Anticipated life of existing pavement is based on planned projects and anticipated life of surface is based on preventive maintenance plans.

All marking materials shall be on Mn/DOT's Qualified Products List and shall be installed according to the manufacturer's specifications. This may include removal of existing pavement markings and other surface treatments as recommended by the manufacturer.

Part VI of the MN MUTCD should be consulted for interim pavement marking requirements

#### 7-4.01.02 Temporary Markings

Temporary markings are used in construction areas and at locations where a temporary hazard must be properly marked until the necessary repairs or improvements can be made.

The types of temporary pavement markings which are used in Minnesota and their respective characteristics are described in Chapter 8 of this Manual.

#### 7-4.01.03 Retroreflectivity

Pavement markings which must be visible at night shall be reflectorized unless ambient illumination assures adequate visibility. Most pavement markings are reflectorized with the exceptions of curb and parking lines.

Retroreflectorization, defined as the return of light from a vehicle head lamp to the driver's eye, is accomplished by retroreflective elements (glass, ceramic, etc) imbedded into the marking material. Road grime, salt, dirt, damp or wet conditions, and snow plow damage reduce the retroreflectivity of a marking. Snow plowing, particularly by the under-body plow blade type, can destroy retroreflectivity by shaving or removing the glass beads. Retroreflectivity of in place pavement markings by handheld or mobile retroreflectometers. The handheld is more accurate while the mobile can collect large quantities of data at highway speeds.

A mobile retroreflectometer has three major components:

1. laser and feedback sensor,
2. distance measuring device, and
3. data acquisition computer.

The data collected from retroreflectometers will be used in the development of a pavement marking management system.

#### 7-4.01.04 Removal of Markings

Markings that are no longer applicable for roadway conditions or restrictions and that might cause confusion for the road user shall be removed or obliterated to be unidentifiable as a marking as soon as practical.

Overly aggressive removal techniques leave scars that can confuse drivers during night and wet conditions.

Do not allow excessive scarring. Any excessive scarring should be repaired to avoid wet weather confusion.

Typically, sandblasting, grinding, and high pressure water jet have been used to remove markings, but the results at times have been less than desirable. For larger projects, truck-mounted, hydraulically controlled, dual scarifying drums with a built-in vacuum system could be considered. A trailing sweeper/vacuum unit recovers the coarser paint/surface waste mixture.

Markings may be temporarily masked with tape (not paint) until they can be removed or obliterated.

Lines and scars from line removal may look different at night. Nighttime inspections are desirable to determine that the pavement markings are visible and understandable under day and night conditions.

### 7-4.02 Standards and Specifications

The Minnesota cycle length for pavement marking is 50 feet. The cycle consists of a 10 foot stripe and a 40 foot gap.

#### Implementation

These guidelines shall be followed on all MN/DOT striping operations:

1. All new surfaces/overlays shall be striped with the 50 foot cycle.
2. All striping done on existing surfaces shall match the cycle currently in place. If the cycle is to be changed from a 40 foot to a 50 foot cycle, the existing pavement markings shall be removed.

### 7-4.03 Application Guidelines

Where used, pavement striping shall conform to the Highway Striping Plan, Standard Plan Nos. 5-297.341, 5-297.342 and Figure 7.1 as follows:

#### 7-4.03.01 Two-Lane, Two-Way Roadways and Passing Lane Sections

1. Two-lane, Two-way roadways (see Figure 7.1) shall have:
  - Broken yellow centerlines
  - Pavement edge lines wherever there is poor color contrast between pavement and shoulders (especially at night), where fog conditions or the unusual hazards may exist, or on approaches to piers, abutments, and retaining walls. Edge lines are used extensively by MN/DOT.
  - Solid yellow lines to restrict passing where required, in accordance with the warrants and criteria for such markings. (See Section 7-4.04 of this chapter).

2. Passing Lane Sections

Pavement markings are needed as follows:

- a. Lane Addition (see Figure 7.4)

Both the pavement edge marking and the diagonal gore marking should be installed immediately prior to the beginning of the left lane line.

b. Passing Lane

A solid double yellow centerline pavement marking should be used to separate the lanes that carry opposing traffic. A broken white skip pavement marking is used to separate traffic moving in the same direction. Pavement edge markings are recommended for both directions of opposing traffic in the passing lane sections.

c. At the Lane Drop

Pavement markings in the lane drop transition area should be provided in accordance with the MN MUTCD, Section 3B-9 and Figure 3B-12. Pavement edge markings are important in the lane drop transition area.

#### *7-4.03.02 Undivided Multi-lane Roadways*

Pavement Markings shall conform to Figure 7.2.

Use the following for all Multi-lane, two-way roadways (four or more lanes):

- Double yellow solid line as centerline markings
- Lane lines
- Pavement edge lines. They are not required in urban areas with curbs.

#### *7-4.03.03 Roadways with Two-Way Left Turn Lanes*

Pavement markings shall conform to Figure 7.3.

#### *7-4.03.04 One-Way Roadways*

One-way roadways shall have the following:

- Lane lines to provide for better use of each lane
- Pavement edge lines on right side or both sides where needed for night visibility or where fog conditions or other unusual hazards may be encountered.

#### *7-4.03.05 Narrow Bridges*

Bridge decks on two-lane, two-way bridges may have double yellow barrier lines depending on bridge width and length. No-passing zones shall begin 1000 feet in advance of a narrow bridge. (see Figure 7.27)

#### *7-4.03.06 Intersections*

Supplementary pavement markings at intersections, where used, shall conform to the standards shown in Figures 7.5a and 7.5b, and Figure 7.22.

#### *7-4.03.07 Interchange Exit and Entrance Ramps*

Pavement markings for interchange ramps, where applied, shall conform to the standards shown in the Highway Striping Plan (see Figure 7.7 and Mn/DOT Standard Plan Sheet 5-297.341).



#### 7-4.03.08 *Auxiliary Lanes and Lane Drops*

The purpose of this section is to clarify the use of these markings. Mn/DOT Standard Plan Sheet 5-297.342 displays the size, spacing of these markings and typical applications for lane drops and auxiliary lanes.

#### 7-4.03.09 *Turn Lanes*

Use of a turn lane message is not required. If the district traffic engineer determines a need, use Figure 7.9 for placement guidance. Messages are required to supplement appropriate signing where a normal through lane is designated for turn option--through and/or turn only operation.

#### 7-4.03.10 *Bypass Lanes at Intersections*

Bypass lanes at intersections should be marked as illustrated in Figure 7.10.

#### 7-4.03.11 *Obstructions in Traveled Way*

See the MN MUTCD, Section 3B-10 and Figure 3B.13.

#### 7-4.03.12 *Transitions*

Approaches to median islands in roadways shall be marked as illustrated in Figure 7.11. Markings for two-lane to four-lane undivided pavements shall be as shown in Figure 7.12.

#### 7-4.03.13 *Special Climbing Lanes*

Pavement markings for special climbing lanes shall conform to the standards shown in Figure 7.13.

#### 7-4.03.14 *Truck Stopping Lane*

Pavement markings for truck stopping lanes at railroad crossings shall be as shown in Figure 7.14.

#### 7-4.03.15 *Free Right Conditions*

Pavement Markings for free right conditions shall conform to the standards shown in Figure 7.15.

#### 7-4.03.16 *Bicycle Lanes*

See the MN MUTCD, Chapter 9 - Traffic Control for Bicycle Facilities.

### 7-4.04 **No-Passing Zone Surveys**

#### 7-4.04.01 *Warrants*

A no-passing zone is warranted when the minimum sight distance is less than the distances shown in Chart 7-3. No-passing zone surveys shall be run at an eye height of 3.5 feet to an object height of 3.5 feet at the sight distance required in Chart 7-3 based upon the 85th percentile speed. The beginning of a no-passing zone shall be the point at which the sight distance first becomes less than that specified in Chart 7-3. The end of the marking shall be that point at which the sight distance becomes greater than the minimum specified in Chart 7-3. A no-passing line should not be less than 500 feet in length unless in advance of a stop sign as specified in Chart 7-2 or as specified in a specific figure. If the end of a no-passing line is less than that specified in Chart 7-4 from the beginning of the line for the next no-passing zone, the two no-passing lines should be connected to provide a continuous restriction through both zones.

If a re-survey of an existing no-passing zone is done and it changes in length, the NO PASSING ZONE pennant does not have to be relocated if the new termini is within 100 feet of the sign.

#### 7-4.04.02 Survey Procedures

The first step in any surveying operation is work zone traffic control. Typically, the work zone traffic control for executing a no passing zone survey is considered a mobile operation. For the methods described below, this implies that workers are not typically stopped on the road for more than 15 minutes and the traffic control devices are vehicle mounted. MN MUTCD, Section 6K, (the Field Manual) Layout 5 would be a typical minimum treatment. Layout 2 would be a higher level of treatment if the road has challenging geometry. Ideally, surveys can be scheduled for the lowest volume periods. Higher ADT volumes, narrow shoulders or intense geometric changes may require additional measures all the way from advance road signs, shadow vehicles or all the way up to lane closures to protect survey workers and the motoring public. These impacts should be assessed and appropriate work zone treatments scheduled to coincide with the no passing zone survey.

There are several methods for surveying no-passing zones and a complete discussion of all those methods is found in the ITE Traffic Control Handbook (2001). An efficient and accurate method is the two vehicle method with both vehicles being equipped with electronic distance measuring instruments and handheld two way radios. In addition, the operators should have optical range finders and height-of-eye sight paddles. This will allow the survey operators the ability to accurately layout no passing zone surveys for both directions with one drive thru on roadways with simple geometry. Range finders will facilitate minimum time on the road determining distances. Ideally, no passing zones are established to an accuracy of 50 feet (approximately one painted skip stripe).

This method requires two vehicles equipped with two-way radios, calibrated distance measuring instruments (DMI), flashing amber lights, and a target for eye height on the lead vehicle. Operators should also have height-of-eye paddles to assist them in unusual geometry. Intermediate sedan size vehicles will work the best but at least the trailing vehicle should be an intermediate sedan with a drivers eye height near the 3.5 foot mark. Verify tire pressure since the DMI's are calibrated at correct tire pressure. Handheld radios will permit the drivers to communicate if they get out of the car to verify distances with the rangefinder. The target should be mounted so the top of the target is at 3.5 feet and should be a bright color different than the vehicle so that a sharp cut off can be observed from 1000 feet. Typically the target should be mounted on the driver's side of the rear of the vehicle. A 4-inch 12 volt LED light from an arrow board can also be a good target but do not use white lights since law prohibits bright white lights projecting from the rear of a vehicle while traveling.

To set the minimum sight distance interval, both cars should park abreast on the roadway or shoulder and the DMI's set at 0.000. The lead vehicle will then move forward the minimum passing sight distance for the speed indicated. When the lead vehicle has gone the required distance, it should stop and the DMI should be reset to 0.000. Not all DMI's have the capability to work in reverse so verify the operation of the particular DMI used. Newer DMI's have GPS capability and can have read outs for the distance between them. The vehicles with drivers are deployed with the appropriate minimum sight distance between them.

From then on, radio contact should be maintained between the vehicles to coordinate their movement. Upon a signal from the trailing vehicle, both vehicles can move forward. The vehicles are to be kept at the correct distance and speed by the lead vehicle observer calling off feet often enough to keep identical readings on the DMI's. To practice this procedure, readings should be called off every 100 feet with the vehicles traveling approximately at 5 mph. Later with added experience, this speed may be increased. If identical readings cannot be maintained, the trailing vehicle should have a lower reading. This will result in the vehicles being farther apart than required. One note of caution, the vehicles should not be backed up to adjust the spacing, unless the DMI's being used are capable of operating backwards.

Most vertical curves can be done from the shoulder. Horizontal curves should be sighted from near the centerline. Given the slow vehicle pace necessary to conduct this study, care must be taken when locating no-passing zones to see that traffic does not become confused or congested. Both vehicles should pull over on the shoulder when the rear driver notices cars being held back.

While making measurements, the driver of the trailing vehicle should stop both vehicles just before the lead vehicle goes out of sight. At this time, the trailing vehicle can move up to obtain identical DMI readings. From this point each vehicle will move forward 50 feet, stop, then move another 50 feet until the target on the lead vehicle goes out of sight over the crest of a hill or is obscured by obstructions along the roadside on horizontal curves. With practice, a team may be able to move continuously and stop only when the lead vehicle goes out of sight. When the lead vehicle's target disappears, the pavement should be marked with spray paint or by some other method.

The trailing vehicle operator should mark to the right of the centerline and the leading vehicle to the left. The trailing vehicle marks will represent the beginning and end of the no-passing zone for vehicles traveling in the direction of the study.

The lead vehicle marks will represent the no-passing zone for the opposite direction of travel. See Figure 7.18 for spotting symbols.

The two vehicles should then proceed forward with identical DMI readings until the driver of the trailing vehicle sees the top of the lead vehicle. Both vehicles are stopped and the trailing vehicle is moved forward to obtain identical DMI readings. Then both vehicles should move forward 50 feet, and stop to determine if the target has re-appeared. This "stepping" is repeated until the target re-appears. Both drivers should then stop and mark the roadway. The lead driver marks on the left of the centerline and the trailing driver marks on the right of the centerline. See Sketch 1 below and Figure 7-16.

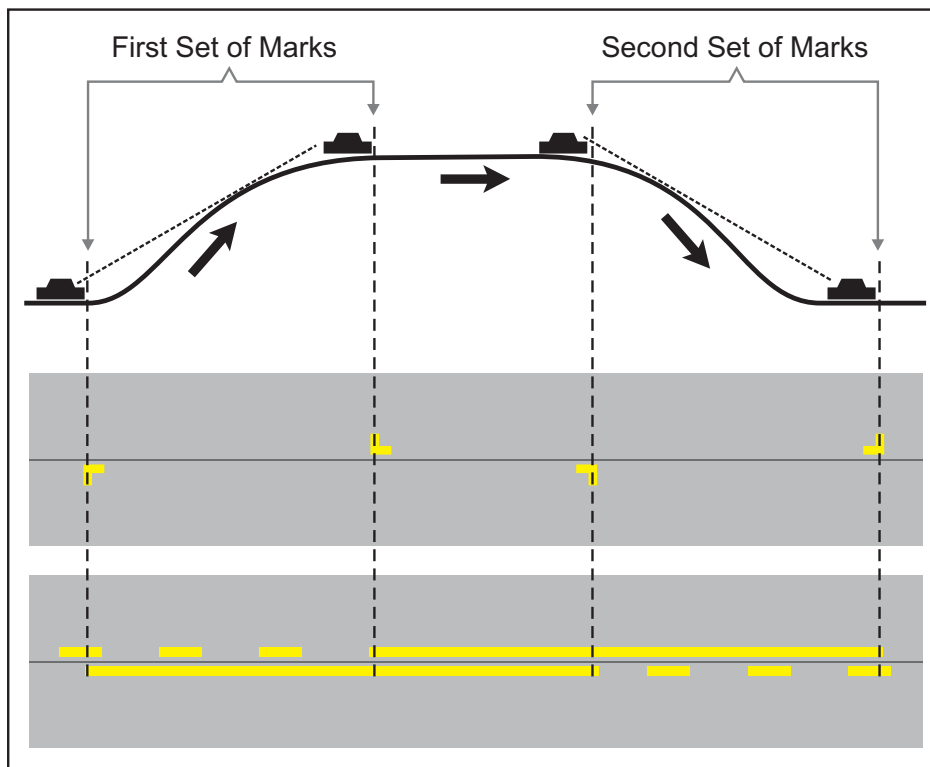

Sketch 1 - Establishing Marks for Identifying No Passing Zone Locations

It is possible for vehicles positioned in-between the study vehicles to become lost in depressions although the vehicles are spaced the minimum sight distance apart and the drivers may see each other. Reverse horizontal curves can create similar situations. See Sketch 2 below.

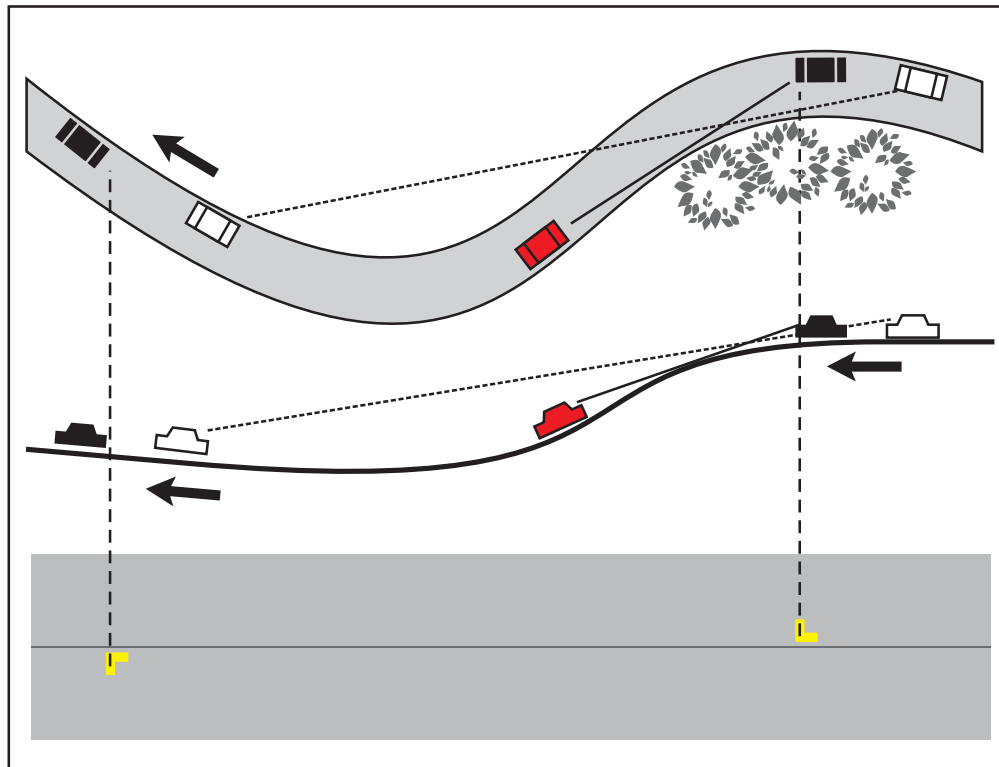

Sketch 2 - How Obstructions and Depressions Cause Vehicle to Become "Lost"

The following procedure is suggested for handling these lost vehicle situations. The driver of the lead vehicle estimates where the low point of a depression is and stops there, after notifying the trailing vehicle of what process is being performed. The trailing vehicle then moves forward until the target on the lead vehicle is in sight. If it is noted by the trailing driver that other on-coming vehicles continue to become lost, the trailing vehicle must move forward to a point where the driver does not lose an on-coming car in the depressions. At this point, a spot should be marked to the right of the centerline by the trailing vehicle's driver. With the trailing vehicle stopped, the lead vehicle then moves forward so it has a DMI reading identical to the trailing vehicle and marks a spot to the left of the centerline. The two vehicles are now synchronized and may proceed with the study. If traffic volumes are high enough, the trailing vehicle can use oncoming cars to spot depressions and sight in on both headlights instead of the target on the lead vehicle. The trailing driver would then radio this reading to the lead driver to re-synchronize the vehicles.

Horizontal curves can be more challenging. Ideally, sight lines should be made from the wheel path nearest the centerline or on the centerline. Drivers may have to exit their vehicles and use the height-of-eye paddles (See Sketch 3). Multiple horizontal curves in a row or compound curves will probably have to be driven in both directions to verify accurate placement.

The minimum passing sight distance used during the study should be changed to accommodate changes in the speed limit. This may require changing passing sight distances while in a no passing zone. If there is any doubt, the longer of the two distances should be used. It is advisable to drive these situations in both directions to confirm placement.

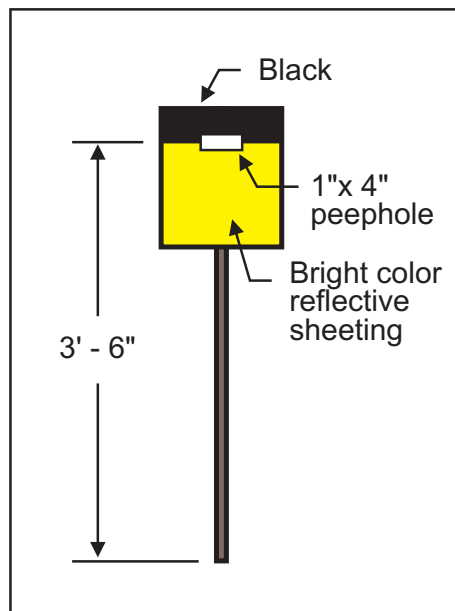

Sketch 3 - Height-of-Eye Paddle

Range finders will help in determining if zones should be connected. If at the end of a potential zone, the trailing operator sees a stop sign ahead, the operator can target the stop sign and get a reading. If that reading is less than the distance in Chart 7-2 plus the gap distance shown in Chart 7-4, then a mark should not be made at the end of the zone until reaching the intersection. Similar range finding techniques can be used to assist in placement of zones in advance of bridges, RR crossings, and medians. The use of temporary pavement tape for spotting marks can also be a time saver in challenging alignment where many gaps need to be connected. The tape can be easily pulled off the pavement without scarring or causing black paint erasure marks.

Before final no passing zones are marked on the pavement, minor adjustments may be made to survey data so that the marking of sight restrictions of short duration are either extended to 500 feet (0.095 mile) or disregarded altogether. If extended, the addition shall be made to the beginning of the zone. Before a sight restriction of less than 500 feet is either installed or disregarded, close field examination shall be made, checking to see if the target is completely out of sight for approximately 2 seconds at the prevailing speed. If the target vehicle does not go completely out of sight, the no-passing zone may be disregarded.

**Sound judgment must be exercised by the No-Passing Zone crew leader, taking into consideration distance traveled and time elapsed during the sight restriction and weighing these factors against the time which both drivers have to observe each other prior to reaching the sight obstruction. If doubt exists, the no-passing zone should be marked to a minimum of 500 feet.**

Chart 7-1 shows a typical form that may be used to log the placement and type of no passing zones. This form is available in an excel spreadsheet from the OTST Pavement Marking Engineer.

#### 7-4.04.03 Removal of Sight Obstructions

When minor maintenance activity can be performed to remove sight obstructions, a request explaining the obstruction shall be sent to the appropriate Maintenance Area for action. Requests for removal(s) of sight obstructions shall normally be limited to work needed to avoid extending a no passing zone.

### 7-4.05 Standard Spotting Procedure

A standard practice of the department is to "spot" or mark guidelines for pavement markings and striping.

Traffic technician, survey crew or contractor does the spotting with a spray paint. Use the spotting system, shown in Figure 7.18 and described below, for all striping.

Match color of spot to the color of the stripe to be painted.

Generally spot as necessary to ensure proper placement of markings. Edgelines and no passing zone lines should not be carried thru public access intersections. They should be carried thru driveways.

### 7-4.06 Special Markings

#### 7-4.06.01 Pedestrian Crossings

An engineering study should be completed to determine the necessity of a pedestrian crosswalk. The study should include the following detailed information:

- Geometrics
- Motorist sight distance
- Traffic volume data including truck traffic and turning movements
- Daily pedestrian volume estimates
- Observation of site characteristics that could divert driver attention from the crosswalk
- Posted speed limit
- Crash history
- Sidewalks and pedestrian pathways

Performing engineering analysis on potential crosswalk locations should result in a more uniform application of the use of pedestrian crosswalks.

Not all sites warrant a pedestrian crosswalk or a crosswalk with additional treatments. The following are possible outcomes that may result from non-uniform application, misuse, or overuse of crosswalk safety treatments.

1. Noncompliance with traffic control devices.

In general, a motorist's decision on whether to comply with a traffic control device message is related to how reasonable the driver perceives the intended message conveyed by the device. If the message is not regarded as reasonable, the likelihood of noncompliance with the device increases.

2. Decrease in safety.

Studies have demonstrated that in some circumstances installing pedestrian crosswalks without some other type of treatment such as signing, warning lights, etc. may not only be ineffective but could actually decrease the safety of crossing the roadway.

3. Disregard of traffic control device.

Overuse of traffic control devices such as signs or striping can lead to a general disregard of the device. Drivers may start to ignore them creating a more hazardous situation.

### Crosswalk Installation Guidelines

Mn/DOT has developed a flowchart (see Chart 7-8) to help decision makers determine whether or not a crosswalk is warranted. The following conditions must be met at all potential crosswalk locations:

- Adequate stopping sight distance for motorists
- Minimal truck traffic
- Minimal vehicle turning movements
- Minimal driver distractions

The following sections support the criteria contained in the flowchart.

#### **Condition Red**

The following design options may be considered at locations that present a relatively high risk to pedestrians:

- Pedestrian bridge or underpass
- Pedestrian signal

#### **Condition Yellow**

The following design options may be considered at locations that present a relatively medium risk to pedestrians:

- Modify existing lane configurations
- Raised median (minimum width of four feet and length of eight feet)
- Curb extensions
- Pedestrian crossing island
- Advanced stop lines and associated signing
- Parking restrictions
- Increased law enforcement
- Modify and/or add lighting

Some Condition Yellow crossings may be determined sufficient without additional crosswalk enhancements.

#### **Condition Green**

Crossings that are identified as having a relatively low risk for pedestrians are those that typically require only pavement markings. Signing may be included based on engineering analysis.

Crosswalk treatments should be selected to address a specific problem, such as crossings at multi-lane locations where multiple conflicts may be expected.

See also "School Crossings" section below.

Place pedestrian crosswalk lines as shown in Figure 7.19 and 7.20. If used, the words PED XING in white may be placed on the approaching pavement lane or lanes for the benefit of approaching traffic. This pavement message should be placed near the PEDESTRIAN CROSSING (W11 2) sign.

In municipalities, crosswalks and pavement markings for school and pedestrian crossings are usually provided by local authorities. The district traffic engineer may provide expertise in the initial efforts by the municipality. The department usually does not provide crosswalks or pedestrian markings in unincorporated areas. However, if a definite need exists, the department may install crosswalk and pavement markings.

#### 7-4.06.02 School Crossings

The following guidelines govern the provision of school markings:

##### 1. School Adjacent to Highway

When a school building or its grounds are adjacent to a trunk highway, the School Advance Warning assembly (S1-1 with appropriate supplemental distance plaque) should be erected. If no crosswalk is provided, the word "SCHOOL" may be applied in white on the approaching traffic lane or lanes near the School Advance Warning assembly. The School Advance Warning assembly and "SCHOOL" pavement message should not be used if the highway right-of-way is fenced and no access is provided directly to the highway.

##### 2. Crosswalk

When a crosswalk is designated within a school zone, install the School Crosswalk Warning Assembly (S1-1 with diagonal down arrow) as specified in the MN MUTCD, section 7B.9. The crosswalks may also be painted and the words SCHOOL XING may be applied in white near the School Advance Warning assembly.

Sidewalks or hard-surface pedestrian paths with ADA compliant pedestrian ramps shall be present before the crosswalks will be installed. It is also recommended to advise the school district to furnish crossing guard protection at these locations to ensure safety.

##### 3. Roadway Message

If a sight restriction exists, the advance warning message SCHOOL XING shall be applied along with appropriate advance warning signs required by the MN MUTCD, Section 4D-15.

In municipalities, crosswalks and pavement markings for school and pedestrian crossings are usually provided by local authorities. The district traffic engineer may provide expertise in the initial efforts by the municipality. The department usually does not provide crosswalks or pedestrian markings in unincorporated areas. However, if a definite need exists, the department may install crosswalk and pavement markings.

#### 7-4.06.03 Railroad Crossing with Stopping Lane

All approaches to railroad grade crossings with a stopping lane in rural areas, except minor spurs, shall be marked as shown in Figure 7.14. The local road authority is responsible for marking all railroad crossings on their roadways.

#### 7-4.06.04 Stop Lines

Use stop lines to emphasize stopping location. Stop lines shall extend across all approach lanes. See Figure 7.22 and guidelines below:

##### 1. Stop Sign

It is preferable to place Stop Line in line with the STOP sign. However, if the STOP sign cannot be located exactly where vehicles are expected to stop, the stop line should be placed at the desired stopping point.

##### 2. Rural Areas

Stop lines in rural locations shall be placed only where the district traffic engineer has determined a need for such control. A traffic control order shall be used.

##### 3. Urban Areas

Stop lines in urban areas should be placed 4 feet in advance of and parallel to the nearest crosswalk line. In the absence of a marked crosswalk, the stop line should be placed at the desired stopping point. In no case shall a stop line be placed more than 30 feet or less than 4 feet from the nearest edge of the intersecting curb line or edge of the thru traveled lane.



#### 7-4.06.05 *Stop Ahead or Signal Ahead*

The STOP AHEAD or SIGNAL AHEAD messages shall be placed where a study by the district traffic engineer has determined a need for this type of warning. A pavement message is usually placed at or shortly beyond the sign giving the same message and may be repeated wherever approach speeds are high or unusual alignment exists. A solid yellow no-passing line shall be used with the STOP AHEAD or SIGNAL AHEAD pavement message (see Figure 7.22).

#### 7-4.06.06 *Parking Space Markings*

Parallel parking spaces, where used, are to be marked with white lines with desirable dimensions of 8 feet by 22 to 26 feet (see MN MUTCD, Section 3B.18 and Figure 3B-8). Parking spaces in state rest areas should be striped as shown in Figure 7.23. Municipal parking spaces are marked by local authorities.

#### 7-4.06.07 *Curb Markings*

Use curb markings only to indicate parking is prohibited at all times. Other restrictions should be shown by standard parking signs. Local authorities may paint curbs yellow under the conditions described in Minnesota Statutes Section 169.34. Local authorities may also prohibit parking at other locations. Permission to restrict parking on trunk highways must be obtained from the appropriate district traffic engineer.

#### 7-4.06.08 *Markings for Speed Enforcement (Airplane Markings)*

See Figure 7.24.

To determine appropriate pavement markings for State Patrol airplanes, each district traffic engineer should confer annually with the patrol captain and chief pilot to review existing zones. This review should identify any zones which can be eliminated because they are not being used.

Use white stripes, with dimensions of 4 feet by 2 feet if in the traffic lane or on the centerline. Use white stripes 6 feet by 2 feet for markings on the shoulder. The marking should extend 2 feet into the driving lane.

A zone should consist of a set of 5 markers and be placed on a straight roadway if possible. Zones should be separated by 1/2 to 1 mile.

#### 7-4.06.09 *Preferential Lane Markings*

##### 1. Bus and Car Pool

See Figure 7.25 for an example of the application of "restricted lane" markers at a freeway on-ramp. The use of "restricted lane" markings shall be documented by a Traffic Control Order and approved by the State Traffic Engineer.

#### 7-4.06.10 *Roundabout Intersections*

The overall concept for roundabout marking is similar to general intersection marking. Typical pavement marking for Roundabout Intersections consists of delineating the entries and marking the circulatory roadway on multi-lane Roundabout Intersections. This task is not easy and must be reviewed by an experienced roundabout designer and the District traffic engineer.

##### 1. Specifying Materials and Installation

Dotted extension lines and crosswalks near roundabout will deteriorate at an accelerated rate. It is recommended that a durable pavement marking be used. This should be clearly spelled out in the specifications and mentioned at the preconstruction conference.

## 2. Single Lane Roundabout Intersections

In general, single lane Roundabout Intersections need no lane arrows or circulatory roadway pavement marking. Bike lane marking within the circulatory roadway is not permitted on any Roundabout Intersections. (See Figure 7.36)

## 3. Multi-Lane Roundabout Intersections

Contact the Office of Traffic, Safety and Operations for assistance in development of pavement marking plans for a multi-lane roundabout.

## 4. Relationship with the MN MUTCD

The Minnesota Manual on Uniform Traffic Control Devices (MN MUTCD) governs the design and placement of signs and markings. The MN MUTCD follows the guidelines in the Federal MUTCD

## 5. Other Standards

Applicable local standards may also govern the design and placement of pavement markings as long as they do not conflict with the MN MUTCD and Mn/DOT policies. Roundabout Intersections present a number of new pavement marking issues that are not addressed in the MN MUTCD or the FHWA Roundabout: “*An Informational Guide*.” On connecting highways coordinate pavement marking with the district traffic office and the local agency to maintain consistency on the facility. Contact the Office of Traffic, Safety and Operations for additional guidance.

## 6. Approach and Entry Pavement Markings

Approach and entry pavement markings consist of dotted edge line extension marking and optional yield line and optional symbol markings. Consult the District Traffic Engineer for optional marking recommendations.

## 7. Approach Marking

Splitter islands will be marked in accordance with standard Mn/DOT guidelines for "Approach Markings for Obstructions" MN MUTCD, Section 3B.19. Where pedestrian traffic is expected and signing is provided, the designer may provide crosswalk pavement markings.

The dotted edge line extension used to demarcate the entry approach from the circulatory roadway is 8-inches wide for single lane entries to the roundabout with a 3 ft line, 3 ft gap and located along the inscribed circle. Set the dotted edge line extension slightly back from the circulating roadway to prevent circulating traffic from scuffing the markings. Do not place pavement marking to demarcate the exit from the circulatory roadway

Pavement word or symbol markings to supplement the signing and yield point marking may be desirable, consult with the District Traffic Engineer for further guidance. These markings should conform to the standards given in MN MUTCD, Section 3B.19.

## 7-5.0 OBJECT MARKINGS

### 7-5.01 Purpose

Object markers are used to identify physical features located within or adjacent to the roadway such as traffic islands, road or street termination and freeway gore areas. Obstacles such as bridge piers and abutments that are close to a traveled lane generally require additional warning techniques.

## 7-5.02 Types of Object Markers

For object marker types, color, and uses, consult the Mn/DOT Standard Signs Manual and the MN MUTCD. Additionally, Mn/DOT uses a Snowplow Marker (X4-5) which is not referenced in the MN MUTCD.

Information pertaining to materials, sheeting, and sign substrates can be found in the Minnesota Standard Specifications for Construction, sections 2564 and 3352.

### 7-5.02.01 Snowplow Marker (X4-5)

This marker indicates to a snowplow operator the beginning and end of a guardrail installation. The snowplow marker is shown in Chart 7-5 and Figure 7.26.

## 7-5.03 Applications and Guidelines

### 7-5.03.01 Bridges Abutments, Piers, and Rails

Bridge abutments, piers, and rails within the width of the approaching shoulders shall be marked with Type 3 Object Markers (Clearance Marker X4-4). A typical application can be found in Figure 7.26.

### 7-5.03.02 Narrow Bridges/One Lane Bridges

A narrow bridge shall be defined as any of the following:

1. A bridge with a minimum driving surface width greater than 18 feet and less than the roadway approach width (not including shoulders).
2. A bridge where engineering judgment of approach grades, curvatures, number of trucks or other considerations justifies a narrow bridge classification.

Narrow bridges should be marked and delineated as shown in Figure 7.27.

A one-lane bridge is defined as any bridge having a clear opening width of 18 feet or less. One-lane bridges shall be marked and delineated as shown in Figure 7.28.

### 7-5.03.03 Cattle Passes/Large Culverts

Cattle passes and larger culverts that meet one of the following descriptions are subject to the provisions of this subsection:

1. Headwalls are present and are not protected by guardrail, subject to engineering judgement
2. Minimum width of 42 inches and a maximum width of 20 feet. Large culverts 20 feet or wider may be treated as a bridge, subject to engineering judgement.
3. Any culvert with an end or opening that is within 8 feet of the outside edge of the shoulder. This 8 foot distance was selected because it may allow a motorist to pull off of a narrow shouldered roadway if other conditions permit.
4. Other structures as determined by the district traffic engineer.

All cattle passes and larger culverts meeting the above criteria should be marked with Type 2 object markers as described in Section 3C.3 of the MN MUTCD and the following:

1. The Type 2 Marker used shall be a 6" x 12" marker constructed of 0.062-inch aluminum or other lightweight material such as fiberglass or flexible urethane sheeting. The marker shall use fluorescent yellow prismatic retroreflective sheeting of a type compatible with the base material.
2. On special flexible post designs that cannot accommodate the 6" x 12" marker, a 3" x 12" marker may be used.
3. Two markers shall be mounted back-to-back on a flexible post or 2-pound steel post. A flexible post is preferred due to its resistance to being knocked down by snowplows and farm equipment. Additionally, it provides better daytime visibility.
4. The two-way marker assembly shall be installed on the near right side immediately in front of the structure as shown in Figure 7.29.

The typical marking of cattle passes and large culverts not protected by guardrail are shown in Figure 7.29.

#### *7-5.03.04 Guardrail*

The approach end of plate beam guardrail installations should be marked with a striped object marker sized to fit the end terminal of the guardrail. The alternating black and reflective yellow stripes shall slope downward at a 45 degree angle toward the side on which traffic is to pass. The marker shall be made of fluorescent yellow prismatic retroreflective sheeting.

On guardrail installations with flat end treatments, the object marker shall fit within the recessed area. On installations with round end treatments, the object marker shall wrap around the circular end treatment and shall be mounted so that the top of the marker is even with the top of the circular end treatment.

Both ends of all guardrails shall be marked with the Snowplow Marker (X4-5) as shown in Figure 7.26.

#### *7-5.03.05 Islands and Interchange Gores*

A typical application of the placement of object markers on island or interchange gores can be found in Chart 7-5 and Figures 7.26 and 7.30.

#### *7-5.03.06 End of Roadway*

A typical placement of markings for a roadway that ends with no alternative vehicular path is shown in Figure 7.26.

#### *7-5.03.07 Driveway Reflectors*

A property owner may mark each side of a driveway entrance with reflectors. Blue colored reflectors are preferred although white (colorless) may be used. Place each reflector on its own structure (not to exceed a 1.0 pound post), not more than 5 feet above the ground, and at least 12 feet from the outside edge of the shoulder to prevent snowplow damage.

Red or yellow reflectors should not be used since they can be easily confused with motor vehicle tail lights. Mn/DOT forces may remove existing reflectors if they obstruct or interfere with the effectiveness of any traffic control device (Reference: MS169.07).

#### *7-5.03.08 Other Objects*

Objects located within the clear zone should be marked with the proper object marker. The clear zone should be determined as stated in Chapter 4 of the Road Design Manual.

## 7-6.0 DELINEATION

### 7-6.01 Types and Materials

For delineator types and colors, consult the Mn/DOT Standard Signs Manual, the MN MUTCD, and Figure 7.30 and Chart 7-6 of this manual.

Information pertaining to materials, sheeting, and sign substrates can be found in the Minnesota Standard Specifications for Construction, sections 2564 and 3352.

### 7-6.02 Delineator Location

The details of height and location of delineators are shown in Figure 7.30 and stated below.

#### 7-6.02.01 Delineator Height and Lateral Placement

When used, install delineators so that the bottom of the delineator is 4 feet above the surface of the nearest traffic lane. Install delineators between 2 feet and 8 feet outside the roadway or pavement edge. On roadways with shoulders, delineators should be installed 6 feet outside the shoulder break. Along curbed sections of roadways, delineators shall be placed not less than 2 feet, nor more than 5 feet, from the curb face.

#### 7-6.02.02 Delineator Spacing

Delineators should be placed at a constant distance from the edge of the roadway except where a guardrail or other obstruction intrudes into the space between the pavement edge and the extension of the line of delineators. The delineators should then be in line with or inside the innermost edge of the obstruction. A typical delineator installation is shown in the MN MUTCD, Section 3D.4, and Figure 7-30 of this manual.

A simple method for field personnel to determine the degree of curve or the radius of a curve is shown in Chart 7-7.

1. Along Horizontal Curves

When applied on the approaches to and throughout horizontal curves, spacing should permit several delineators to always be visible along the curve ahead of the driver. Figure 3D-1 and Table 3D-1 of the MN MUTCD show the recommended spacing for delineators along horizontal curves. A typical layout for delineator spacing on horizontal curves is shown in Chart 7-7.

2. Along Vertical Curves

When applied on crest vertical curves, the spacing should permit a minimum of three delineators to be visible from all points along the centerline of the curve at an eye level of 4 feet above the pavement.

3. Along Tangent

When used, delineators should be spaced 0.1 mile apart along the through roadway, except along acceleration and deceleration lanes where the spacing should be as indicated in Section 3D.4 of the MN MUTCD.

#### 7-6.02.03 Divided-Highway Crossovers

Delineation of divided-highway crossovers is shown in Figure 7.32.

#### 7-6.02.04 Interchanges

Delineation of cloverleaf and diamond interchanges is shown in Figures 7.33 through 7.35.

#### 7-6.02.05 Guardrail

Three cable guardrail shall be delineated as shown in the current version of Mn/DOT Standard Plate Nos. 8330 and 8331. The color of the reflective sheeting shall match the color of the adjacent edge line.

Plate-beam guardrail delineation is under investigation.

### 7-6.03 Deer Reflectors

Each district may make the decision to remove existing deer reflectors based on any of the following conditions:

1. The existing installations are more than six years old and there is no intent of maintaining them due to replacement costs (lack of maintenance funds), complicated installation procedures, and a lack of staff.
2. The existing installations are a problem for maintenance activities (their lateral placement causes mowing and snow removal problems).
3. Written documentation indicates that either the number of deer kills has not been significantly reduced or the number of deer kills has actually increased.

### 7-7.0 REFERENCES

1. Minnesota Department of Transportation, Minnesota, Manual on Uniform Traffic Control Devices, current edition.
2. American Association of State Highway Officials, A Policy on Geometric Design of Rural Highways, current edition.
3. State of Minnesota, Minnesota Statutes.
4. Minnesota Department of Transportation, Standard Signs Summary, current edition.
5. Minnesota Department of Transportation, Road Design Manual, current edition.
6. Mn/DOT Bikeway Facility Design Manual, current edition.

[www.dot.state.mn.us/bike/bikewaysdesignmanual.html](http://www.dot.state.mn.us/bike/bikewaysdesignmanual.html)

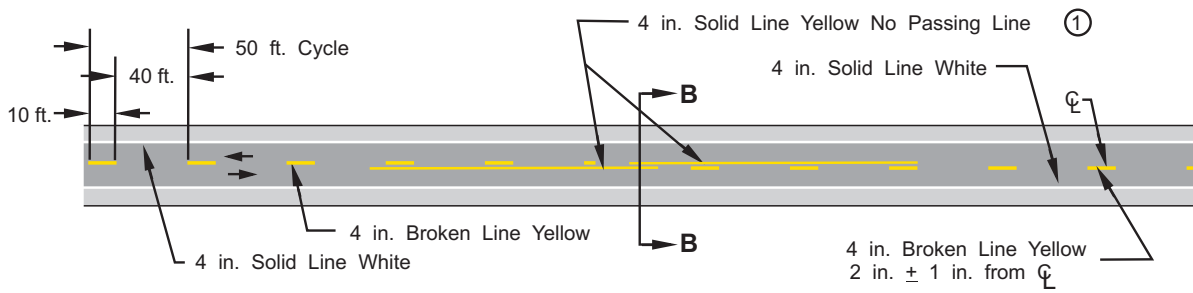
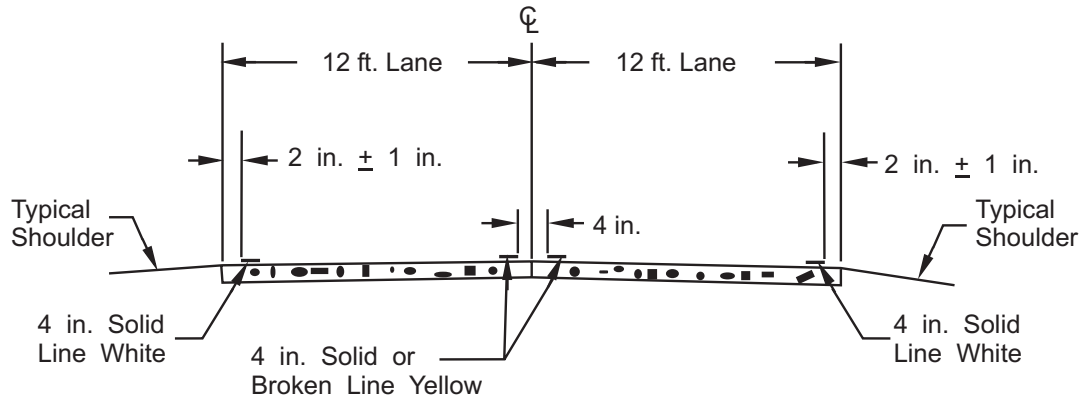

① Contact traffic engineer for No Passing Survey

NOTE: Do not place longitudinal pavement marking lines on the roadway joints.

Text Ref.: 7-4.03.01

May 15, 2008

**TWO-LANE, TWO-WAY ROADWAY  
PAVEMENT MARKING DETAILS**

**FIGURE  
7.1**

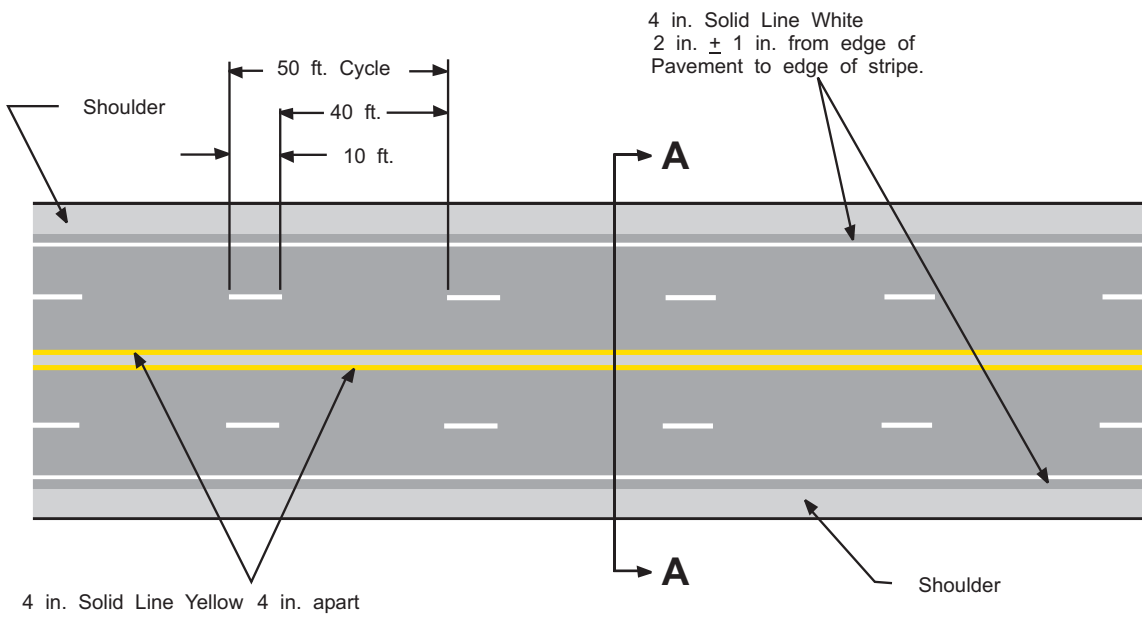
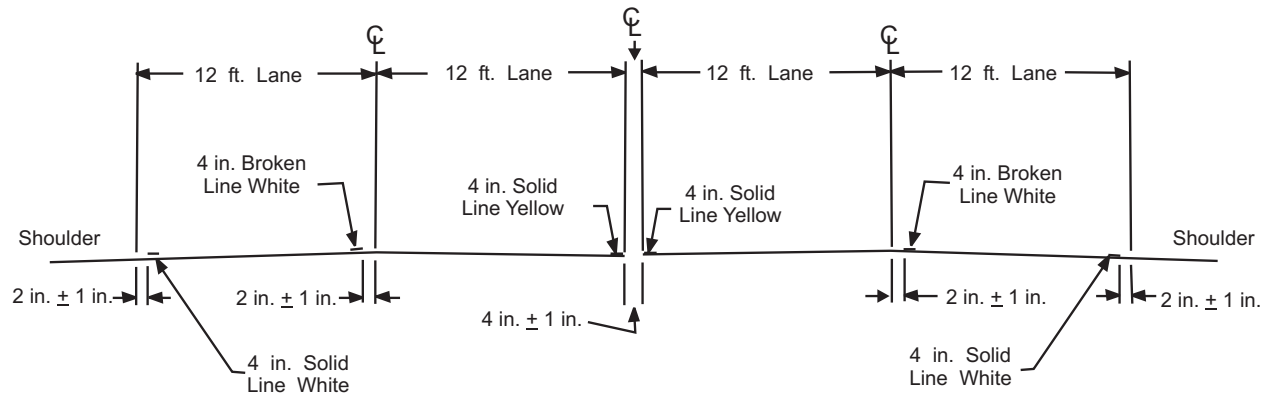

NOTE: Do not place longitudinal Pavement Marking Lines on the roadway joints.

Text Ref.: 7-4.03.02

May 15, 2008

**MULTI-LANE UNDIVIDED ROADWAY  
PAVEMENT MARKING DETAILS**

**FIGURE  
7.2**



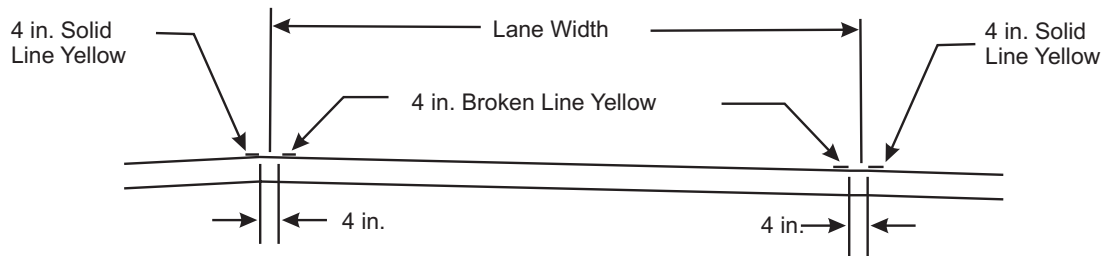

SECTION C-C

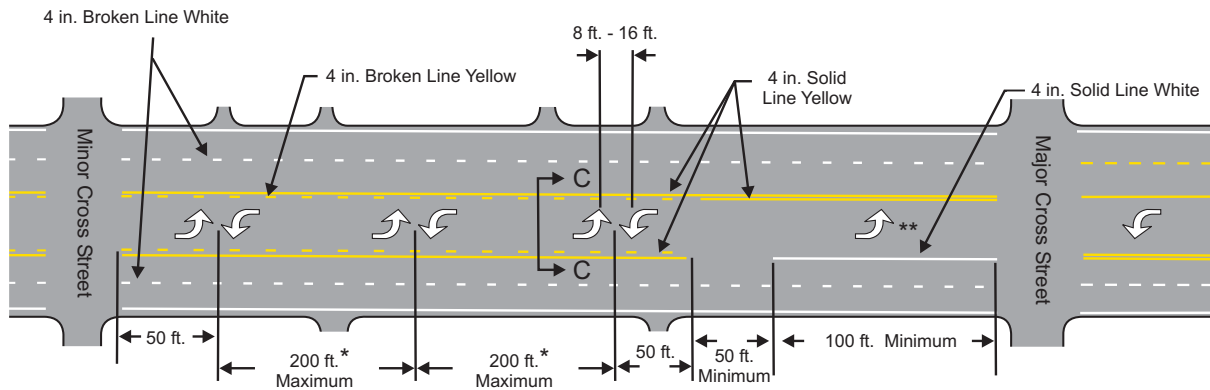

\* These distances should be equal. The Pavement Arrows are placed to show the operation and do not have to line up with any of the driveways.

\*\* See "TYPICAL MESSAGE PLACEMENT FOR TURN LANES" for the number and placement of turn arrows and how to introduce this lane -- Figure 7.9

Text Ref.: 7-4.03.03

May 15, 2008

**TWO-WAY LEFT TURN LANE  
PAVEMENT MARKING DETAILS**

**FIGURE  
7.3**

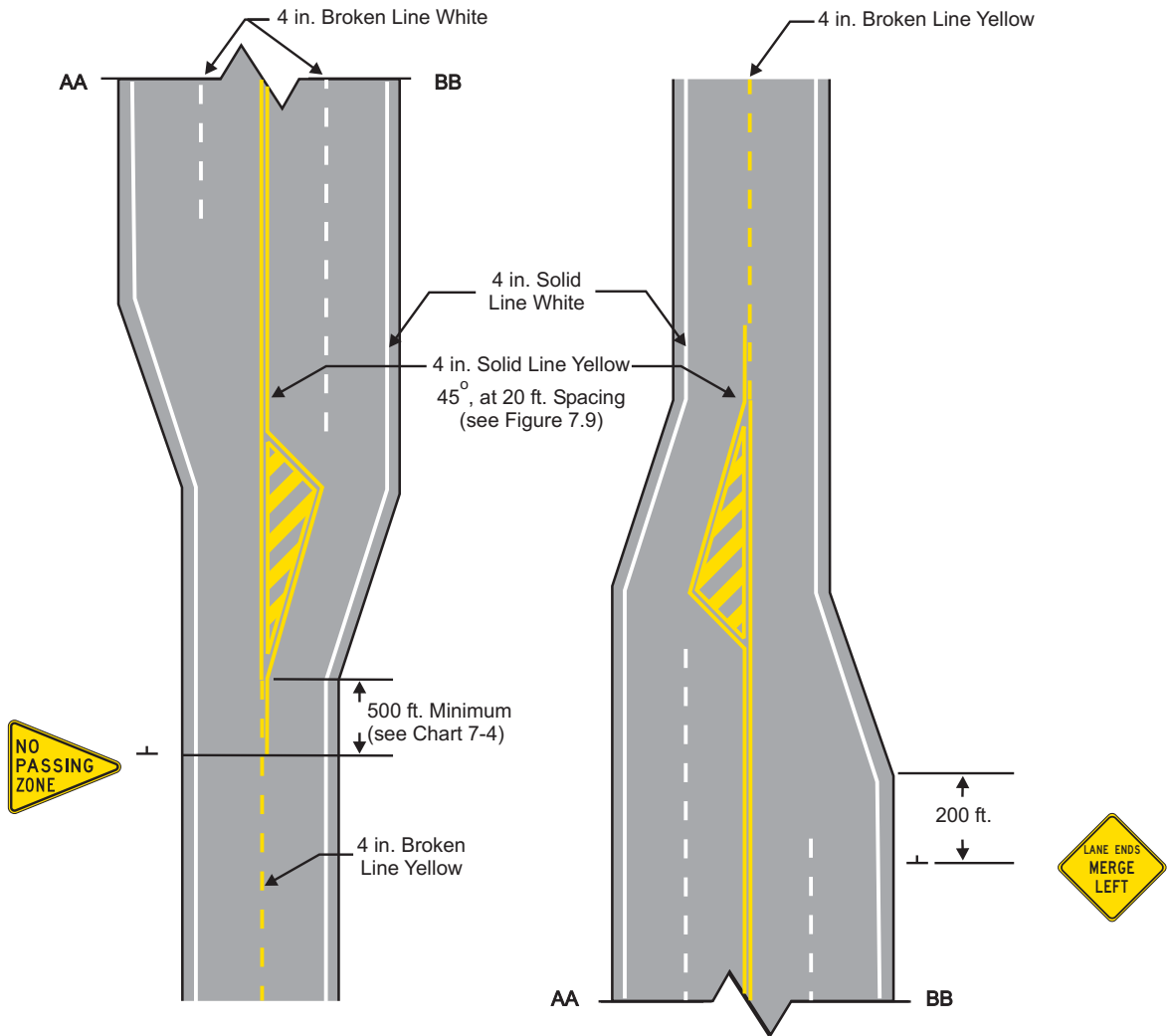

NOTE:

1. The same treatment is used for both approaches.
2. The lane skip striping shall end approximately 50 feet beyond the Lane Reduction sign.
3. More details on signing can be found in Chapter 6.

Text Ref.: 7-4.03.01 (2a)

<p>October 31, 2008</p>	<p><b>PASSING LANE SECTION PAVEMENT MARKINGS</b></p>	<p>FIGURE <b>7.4</b></p>
-------------------------	--	------------------------------

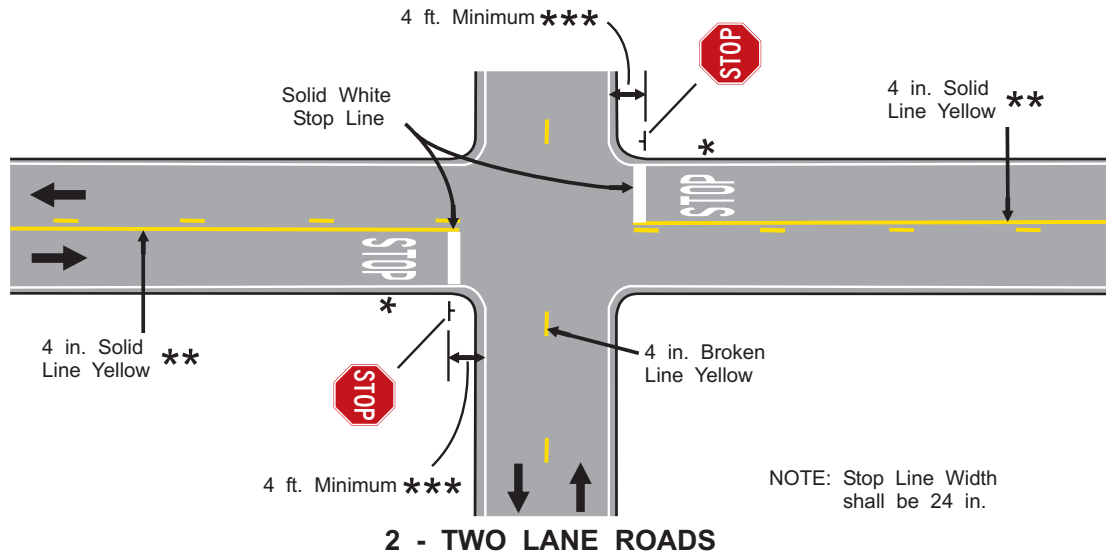

- \* Optional
- \*\* see Charts 7-2 and 7-4
- \*\*\* from Curb Line or near edge of the thru traveled lane.

Text Ref.: 7-4.03.06

<p>May 15, 2008</p>	<p><b>MAJOR INTERSECTION PAVEMENT MARKINGS</b></p>	<p>FIGURE <b>7.5A</b></p>
---------------------	--	-------------------------------

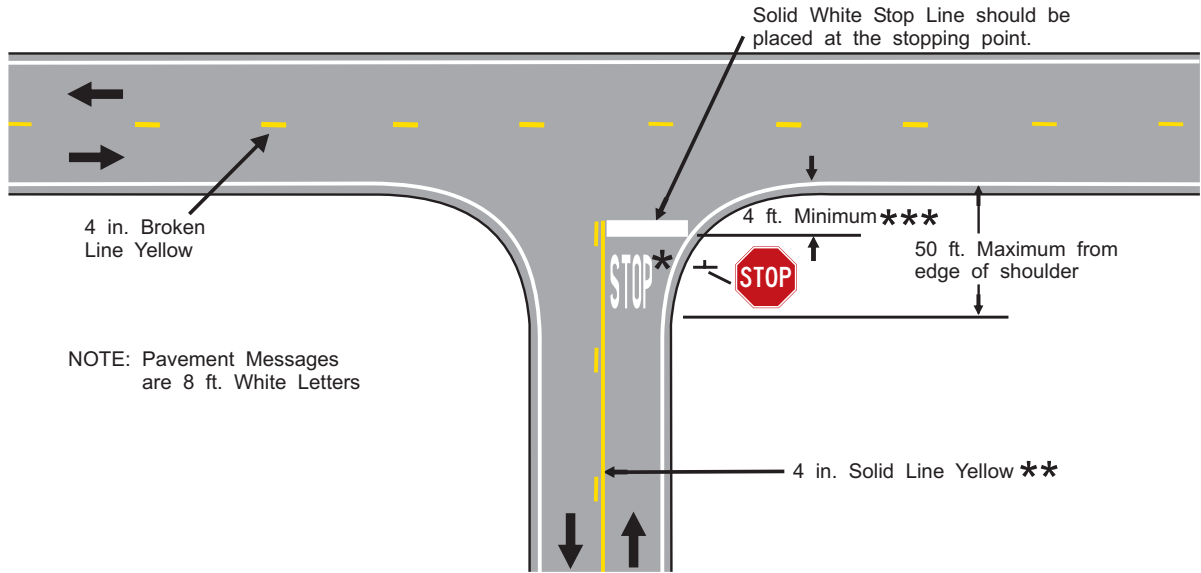

LARGE RADIUS INTERSECTION

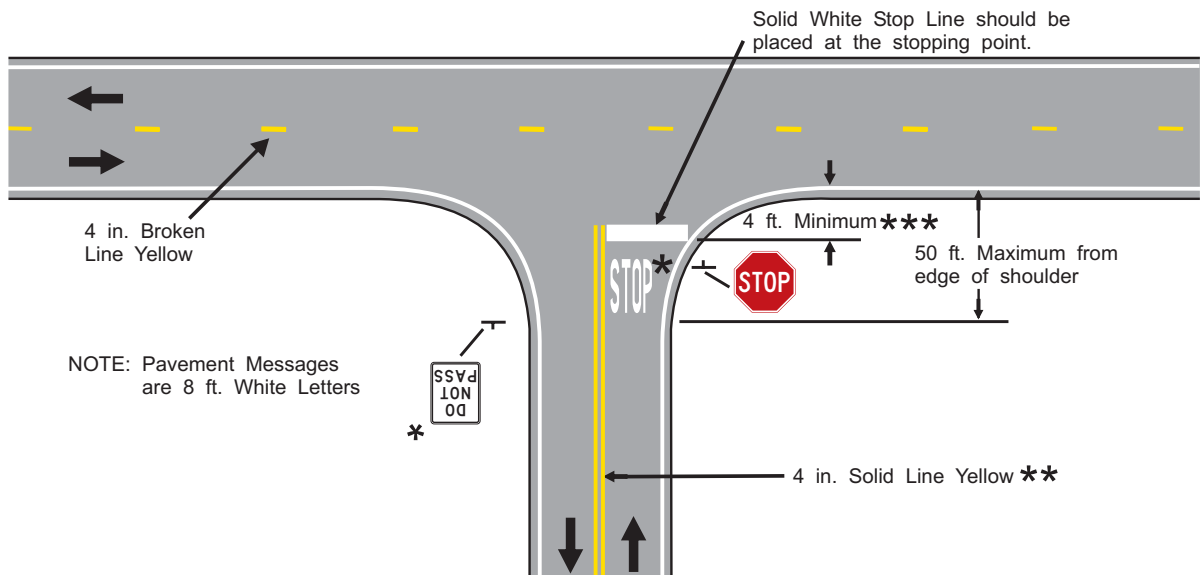

LARGE RADIUS INTERSECTION

- \* Optional
- \*\* see Charts 7-2 and 7-4
- \*\*\* from Curb Line or near edge of the thru traveled lane.

Text Ref.: 7-4.03.06

May 15, 2008

MAJOR INTERSECTION PAVEMENT MARKINGS

FIGURE  
7.5B

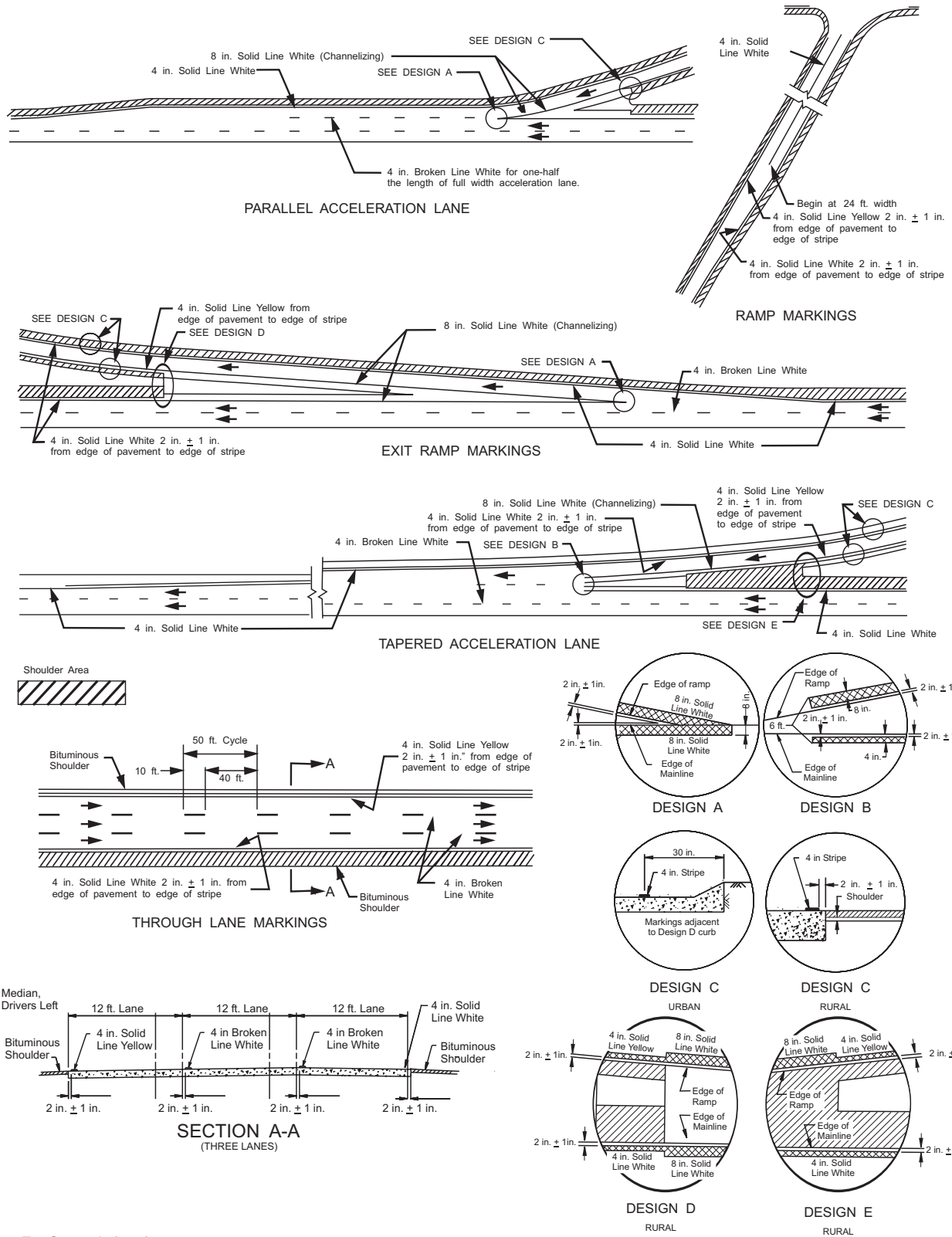

Text Ref.: 7-4.05.07

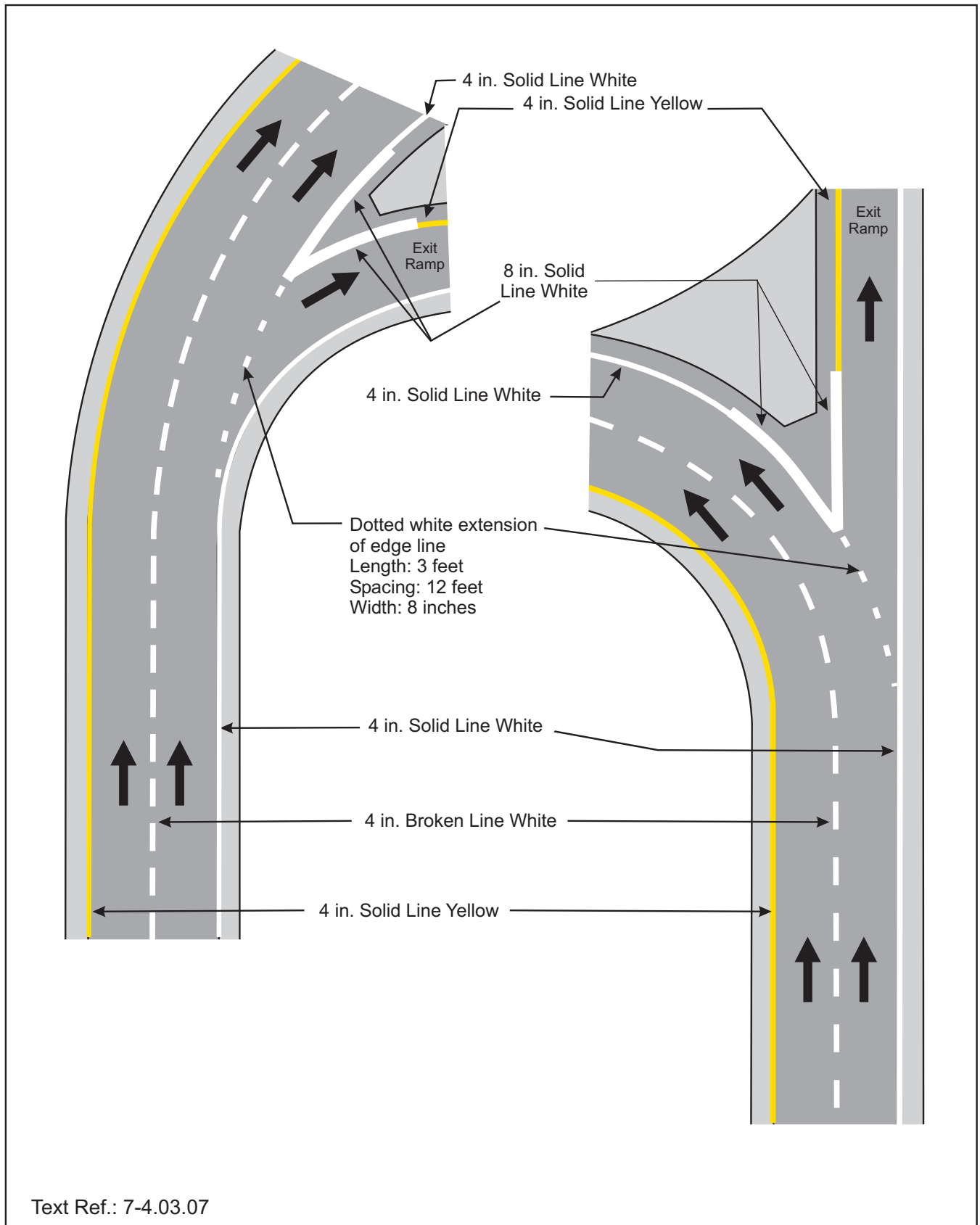

Text Ref.: 7-4.03.07

May 15, 2008	<b>EXIT RAMP ON CURVED ROADWAY PAVEMENT MARKINGS</b>	<b>FIGURE 7.7</b>
--------------	--	-----------------------

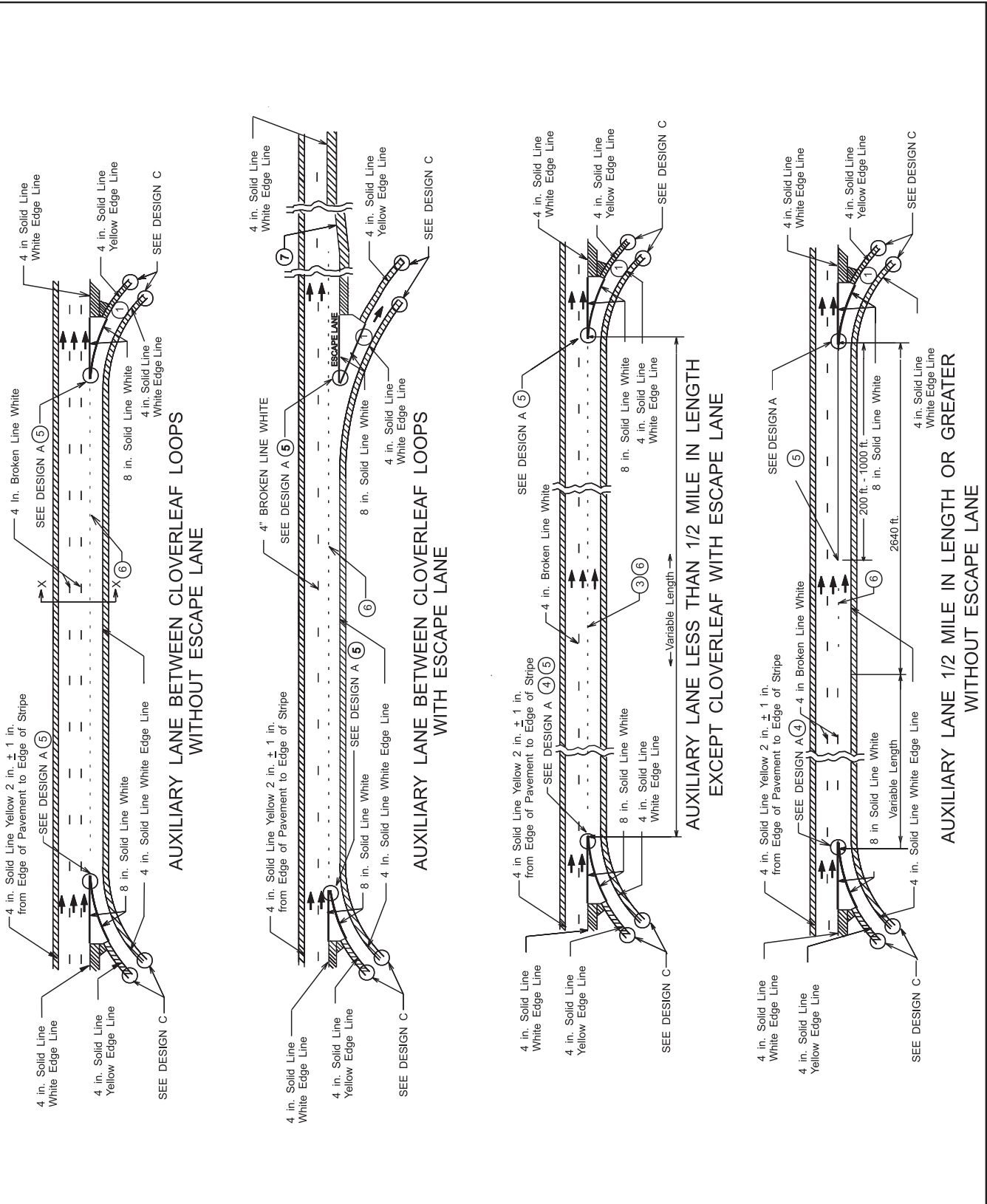

Text Ref.: 7-4.05.09

May 15, 2008

**AUXILIARY LANE PAVEMENT MARKINGS**

**FIGURE 7.8A**

NOTES:

- ① Extend 8 in. solid line white 50 ft. minimum beyond gore area to compensate for sharp curvature.
- ② On pavements over 24 ft. wide (i.e. 27 ft.) edge lines will be placed so lanes are a maximum of 12 ft. wide.
- ③ Omit broken line white when auxiliary lane is less than 1000 ft. long. Extend 8 in. solid line white up to 200 ft., if deemed necessary for better delineation, at the discretion of the district traffic engineer.
- ④ Extend 8 in. solid line white for 200 to 300 ft., on curvature or for other situations where needed for better delineation, at the discretion of the district traffic engineer.
- ⑤ When the distance between Design A Details exceeds 1000 ft., start 8 in. solid line white 100 ft. before right side Design A Detail and place standard 4 in. broken line white ( 10-40 ) between the solid lines.
- ⑥ 8 in. dotted line white, 3 ft. long with a 12 ft. gap, as detailed in Figure 3-11a of the MN MUTCD. This type of stripping should be used whenever a lane is dropped.
- ⑦ Extend 8 in. solid line white the entire length of the escape lane and to the end of the taper. Pick up the normal 4 in. solid line white beyond the taper. The taper must be at least 50:1.

ZZZZ DENOTES SHOULDER AREA

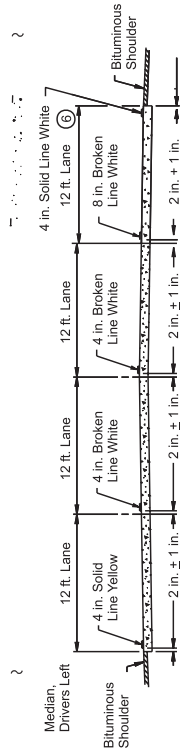
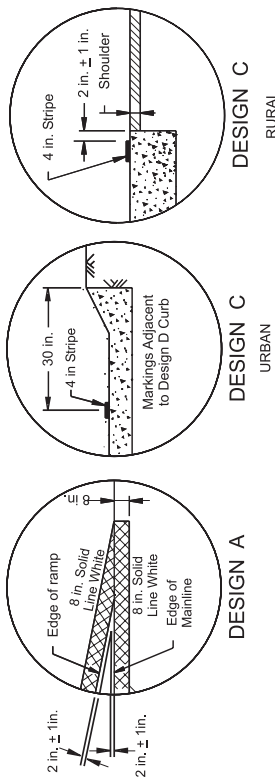

SECTION X - X ②

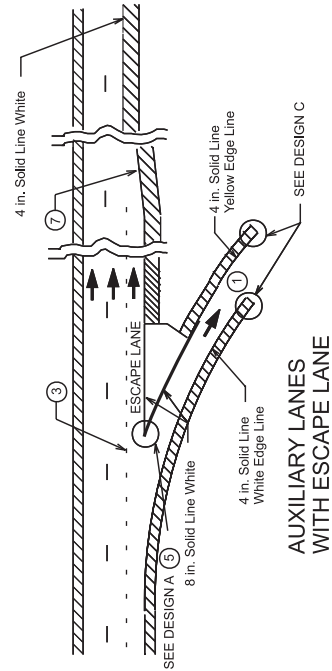

AUXILIARY LANES WITH ESCAPE LANE

Text Ref.: 7-4.05.08

May 15, 2008

AUXILIARY LANE PAVEMENT MARKINGS

FIGURE 7.8B



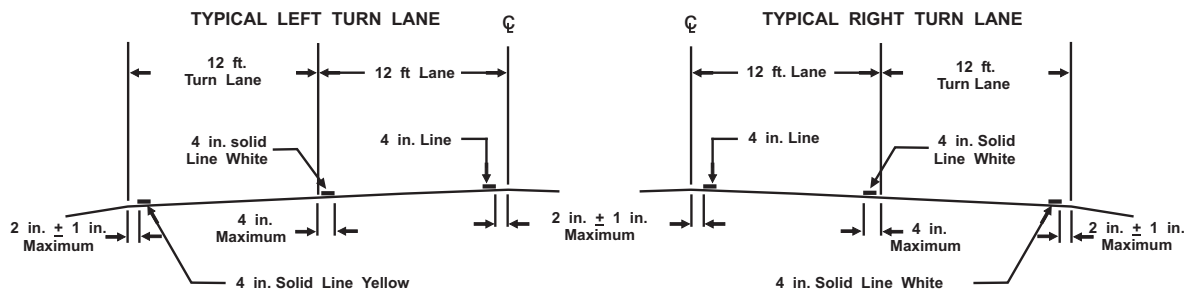

TYPICAL MESSAGE PLACEMENT FOR TURN LANES

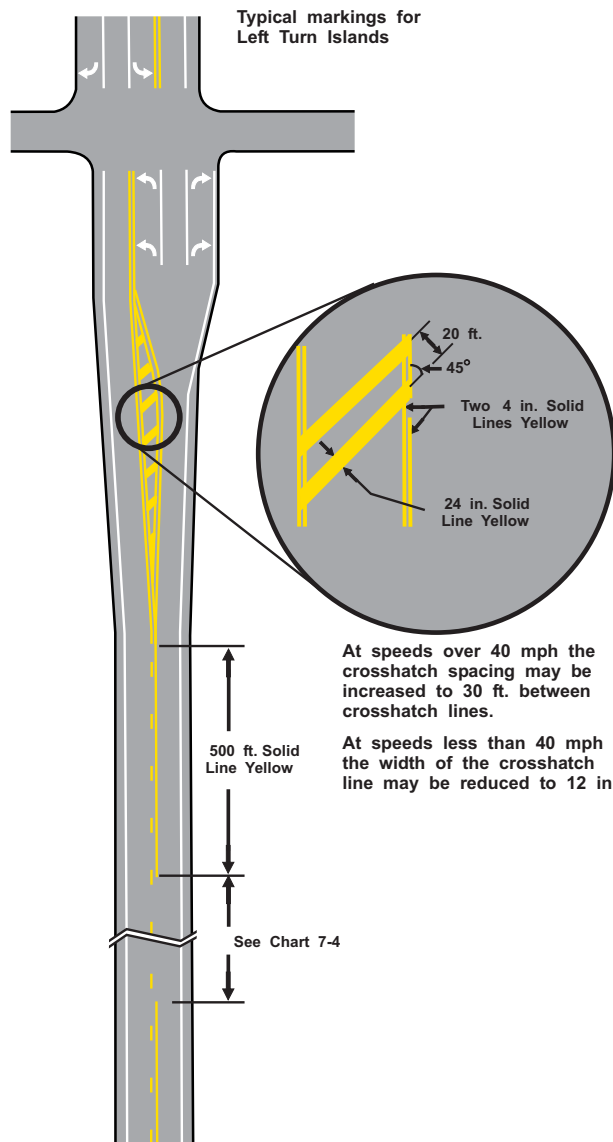
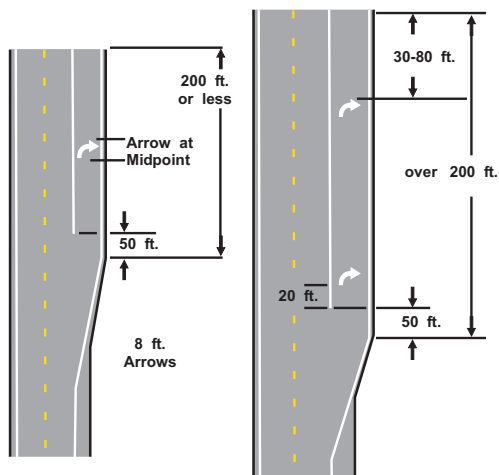

Text Ref.: 7-4.03.09

May 15, 2008

TURN LANE AND LEFT TURN ISLAND PAVEMENT MARKINGS

FIGURE 7.9

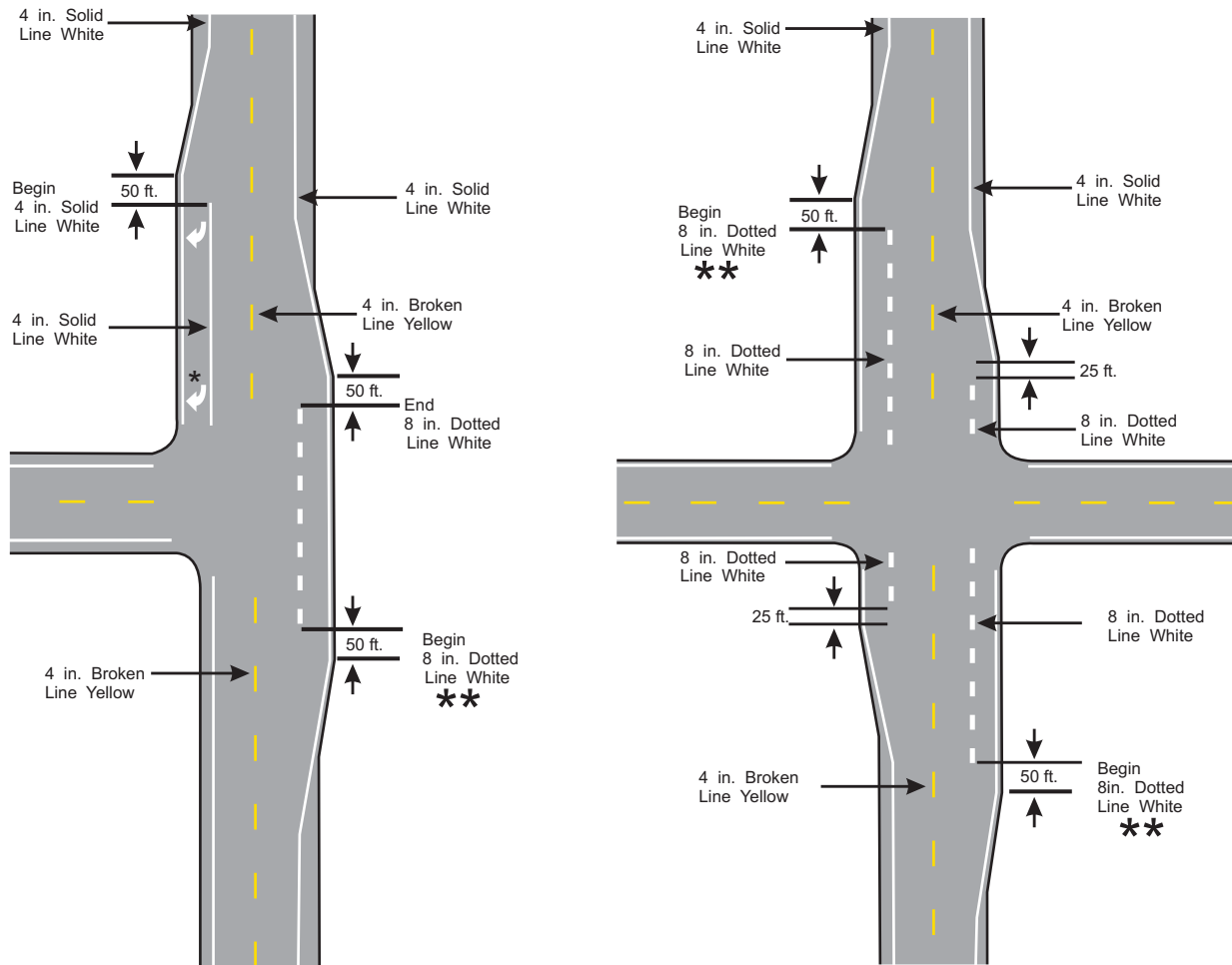

Note:

1. No Passing Zones at intersections shall be striped for 500 feet on both sides of the intersection if it is located within the city limits. No Passing Zones at intersections shall be striped if located within any established No Passing Zone. No Passing Zone striping is optional at the discretion of the district traffic engineer for rural intersections. See Chart 7-4.
2. See Figure 6.17 for signing.

\* See Figure 7.9 for the typical message placement of turn arrows.

\*\* 3 foot long line with a 12 foot gap.

Text Ref.: 7-4.03.10

<p>October 31, 2009</p>	<p><b>BYPASS LANE PAVEMENT MARKINGS</b></p>	<p><b>FIGURE 7.10</b></p>
-------------------------	---	-------------------------------

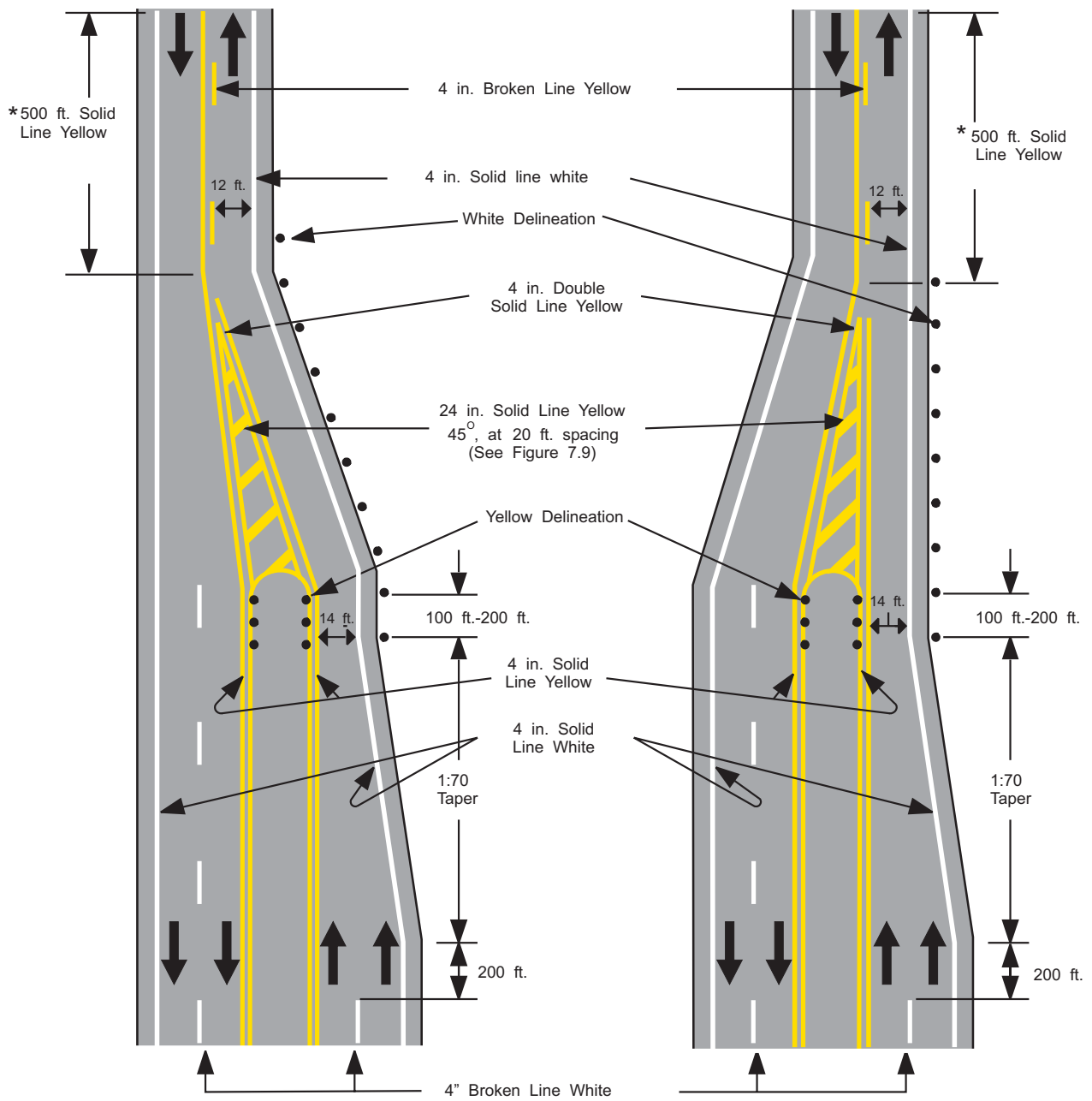

\* See Chart 7-4.

Text Ref.: 7-4.03.12

May 15, 2008

**DIVIDED ROADWAY TRANSITION PAVEMENT MARKINGS**

**FIGURE 7.11**

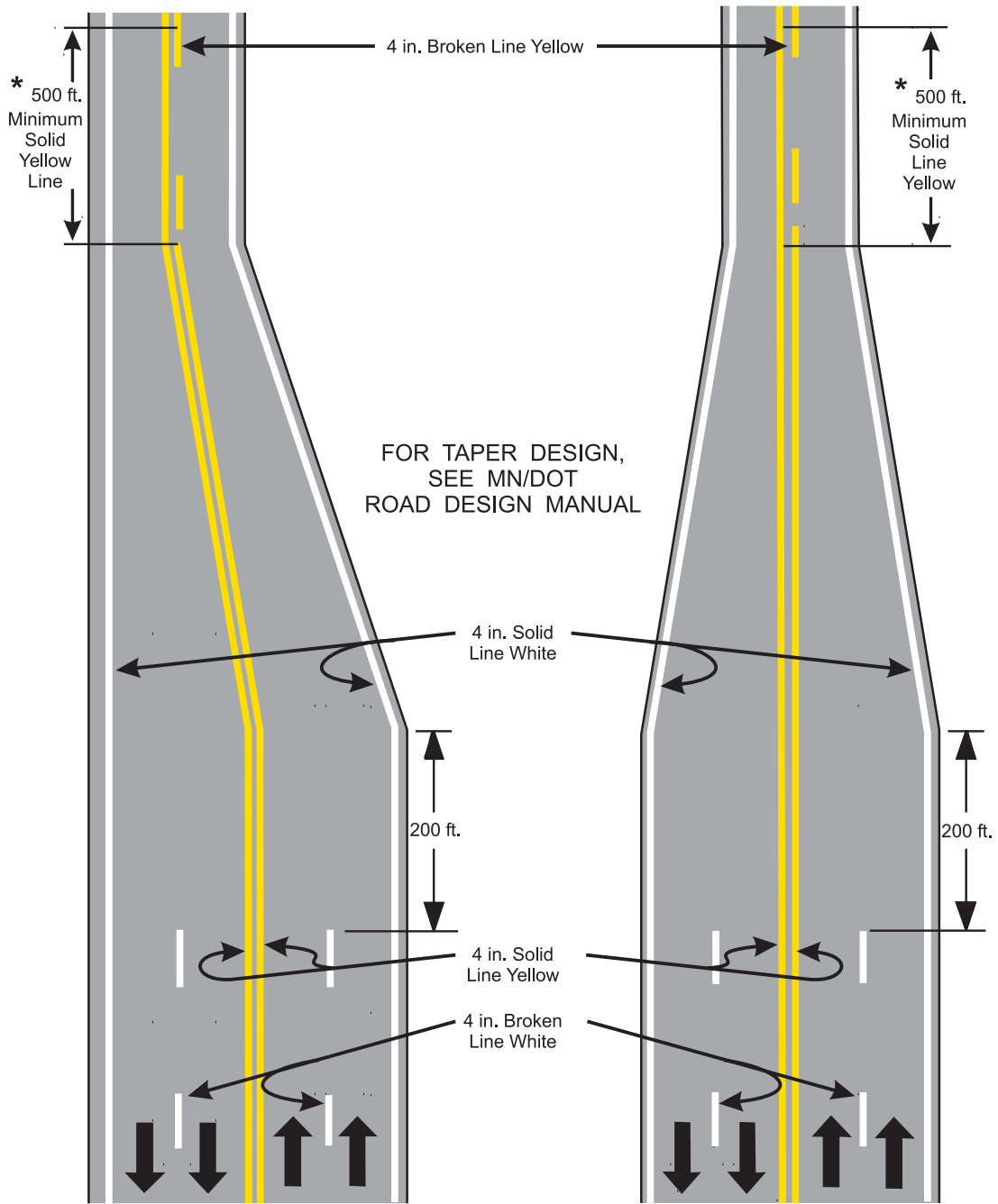

\* See Chart 7-4.

Text Ref.: 7-4.03.12

May 15, 2008

**UNDIVIDED ROADWAY TRANSITION  
PAVEMENT MARKINGS**

**FIGURE  
7.12**

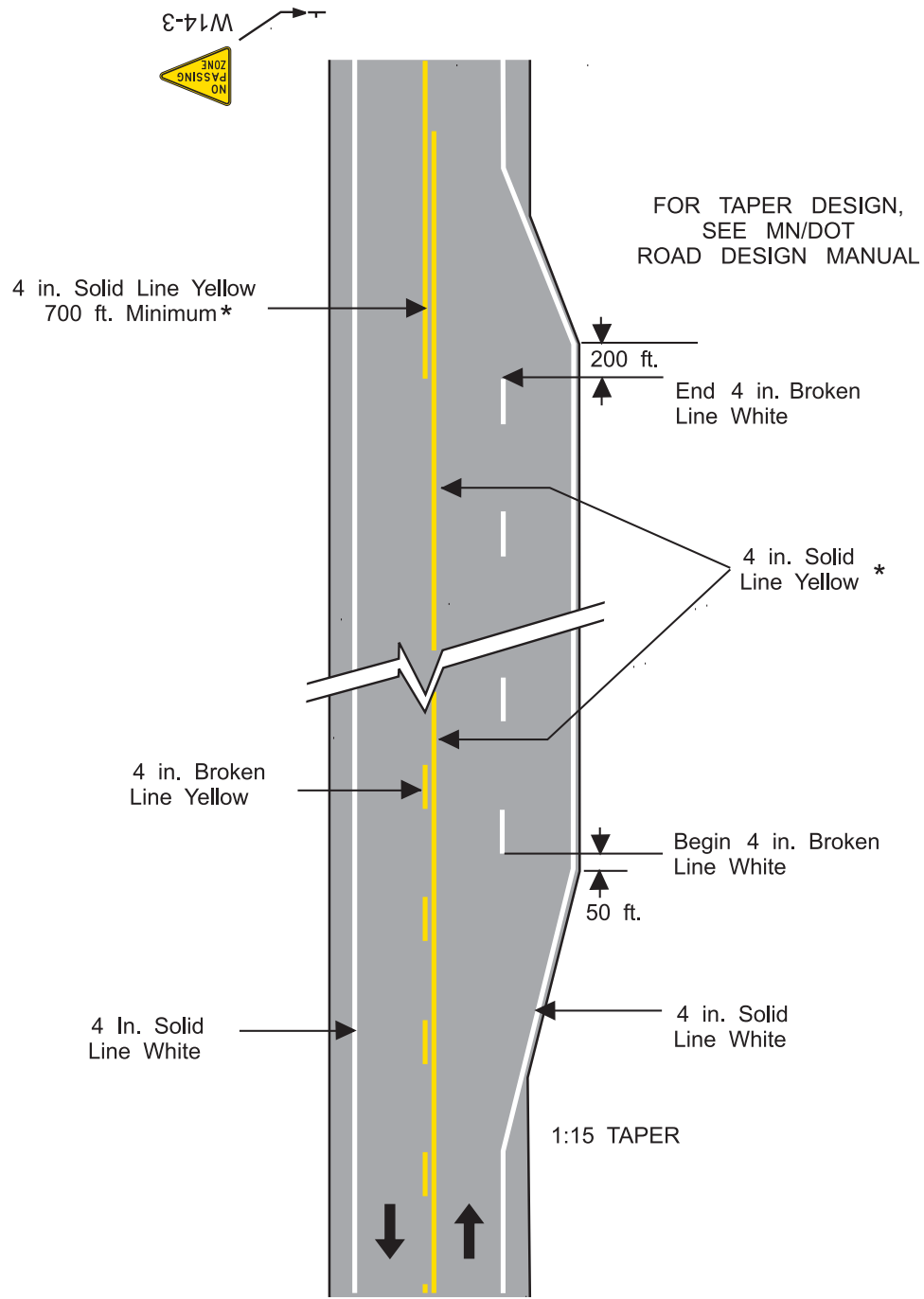

\* See Chart 7-4.

Text Ref.: 7-4.03.13

May 15, 2008

**TRUCK CLIMBING LANE  
PAVEMENT MARKINGS**

**FIGURE  
7.13**



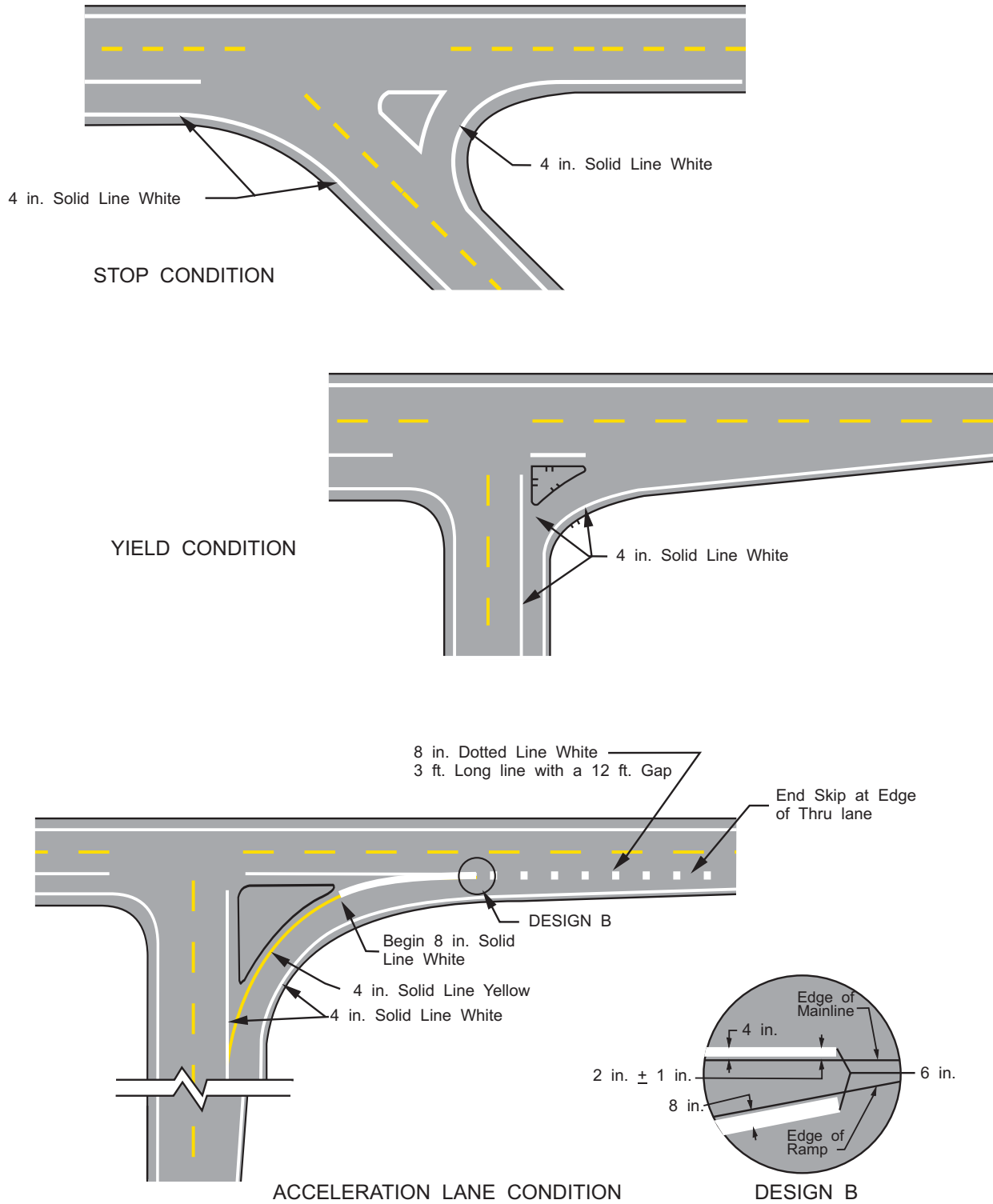

Text Ref.: 7-4.03.15

October 31, 2009

**FREE RIGHT TURN LANE PAVEMENT MARKINGS**

**FIGURE 7.15**

a - No-passing zone at VERTICAL CURVE

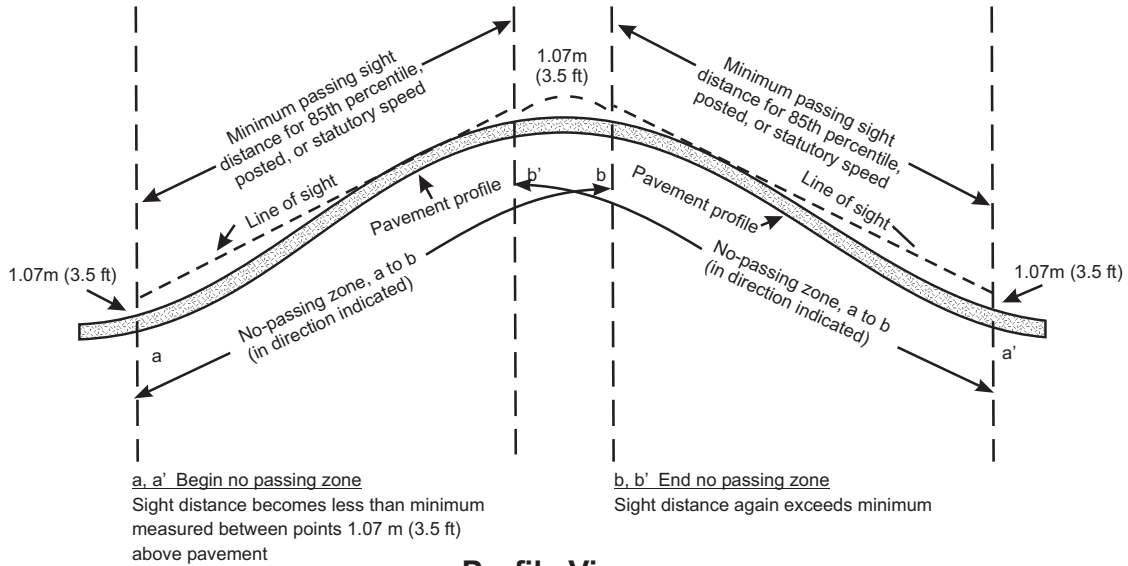

**Profile View**

NOTE: No-passing zones in opposite directions may or may not overlap, depending on alignment.

b - No-passing zone at HORIZONTAL CURVE

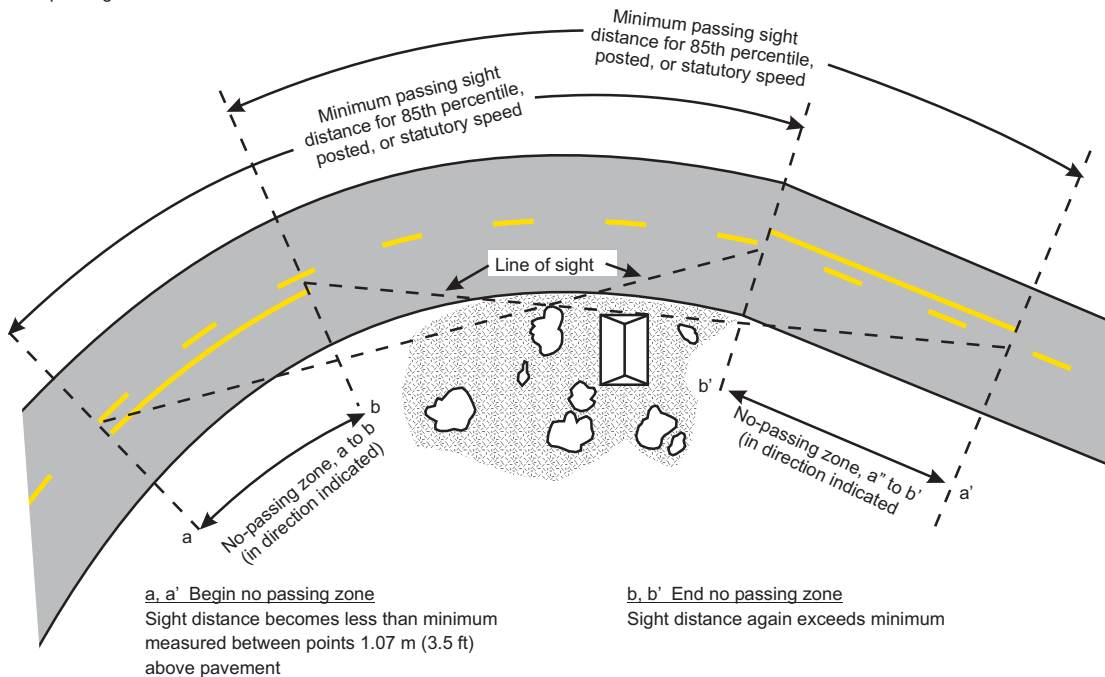

**Plan View**

NOTE: No-passing zones in opposite directions may or may not overlap, depending on alignment.

Text Ref.: 7-4.04.02

<p>May 15, 2008</p>	<p><b>NO PASSING ZONE PROFILES</b></p>	<p><b>FIGURE 7.16</b></p>
---------------------	--	---------------------------



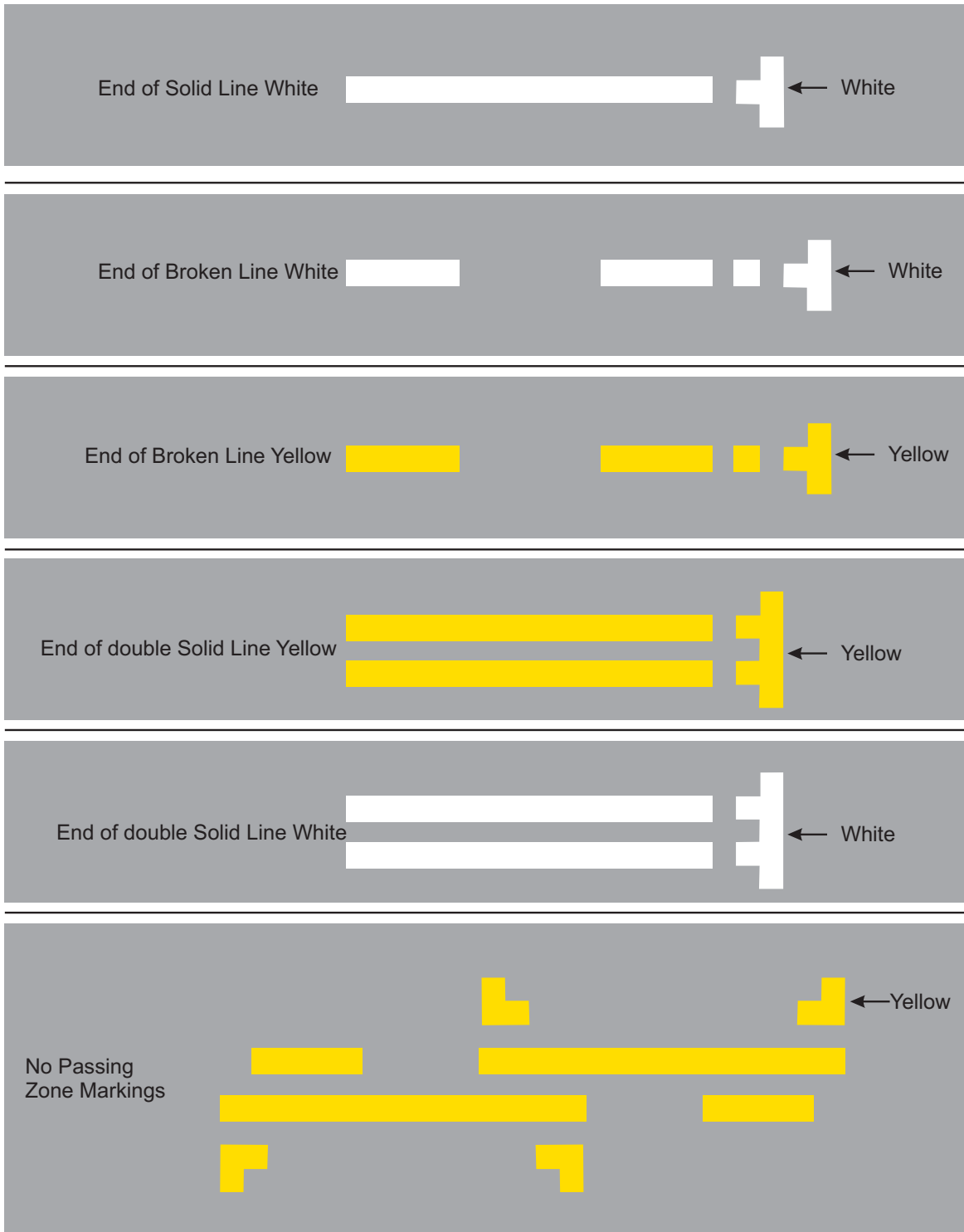

Text Ref.: 7-4.05

May 15, 2008

**SPOTTING SYMBOLS FOR PAVEMENT STRIPING**

FIGURE  
**7.18**

Posted Speed Limit (mph)	Minimum distance of Pavement Marking from Intersection (feet)
30	75
35	125
40	200
45	275
50	350
55	450
60	525
65	625

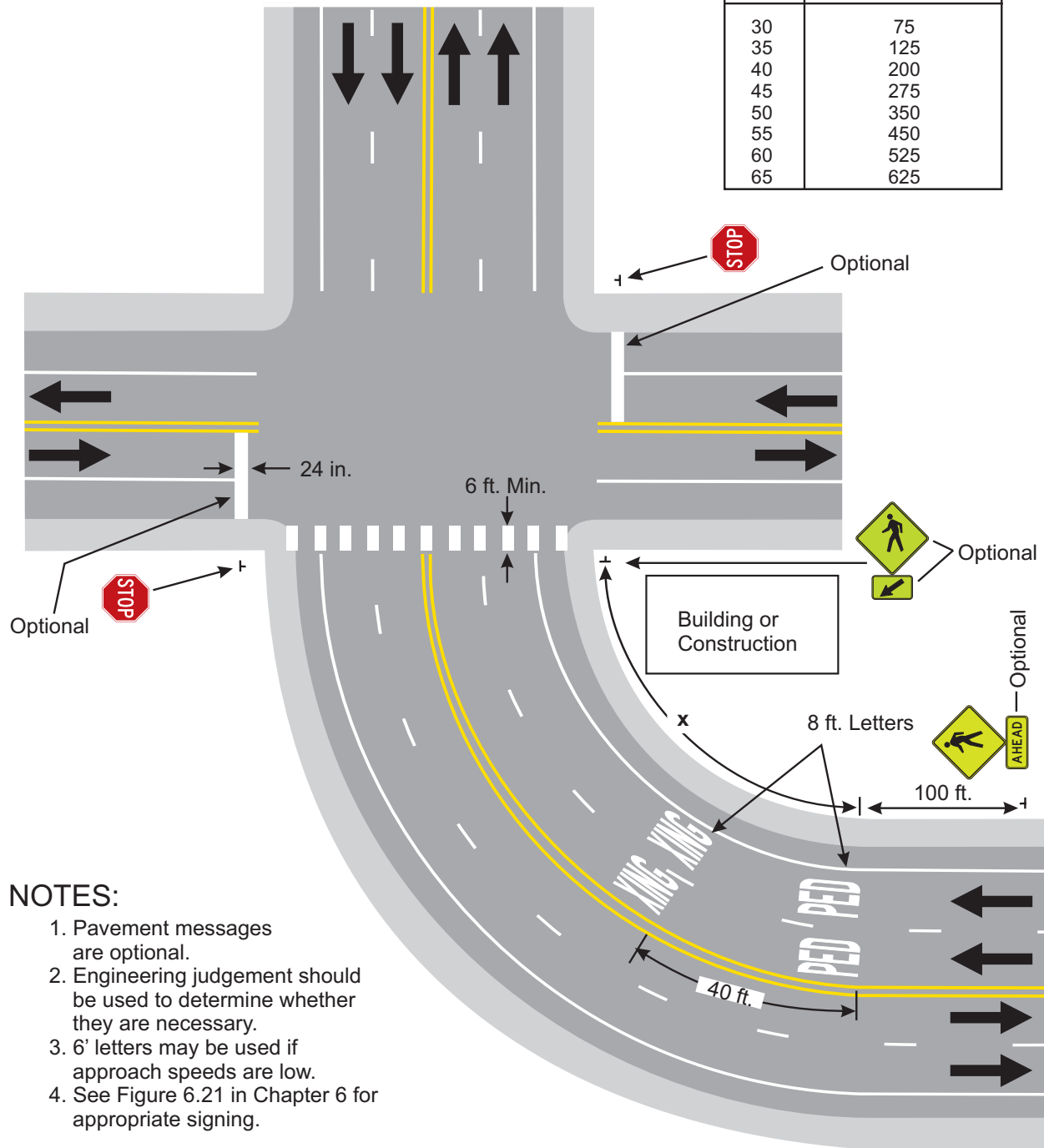

**NOTES:**

1. Pavement messages are optional.
2. Engineering judgement should be used to determine whether they are necessary.
3. 6' letters may be used if approach speeds are low.
4. See Figure 6.21 in Chapter 6 for appropriate signing.

Text Ref.: 7-4.06.01

May 15, 2008

**PEDESTRIAN CROSSWALK MARKINGS**

**FIGURE 7.19**

(L) WIDTH OF INSIDE LANE	(W) WIDTH OF PAINTED AREA	(S) WIDTH OF SPACE
9 feet	2.0 feet	2.5 feet
10 feet	2.5 feet	2.5 feet
11 feet	2.5 feet	3.0 feet
12 feet	3.0 feet	3.0 feet
13 feet	3.0 feet	3.5 feet

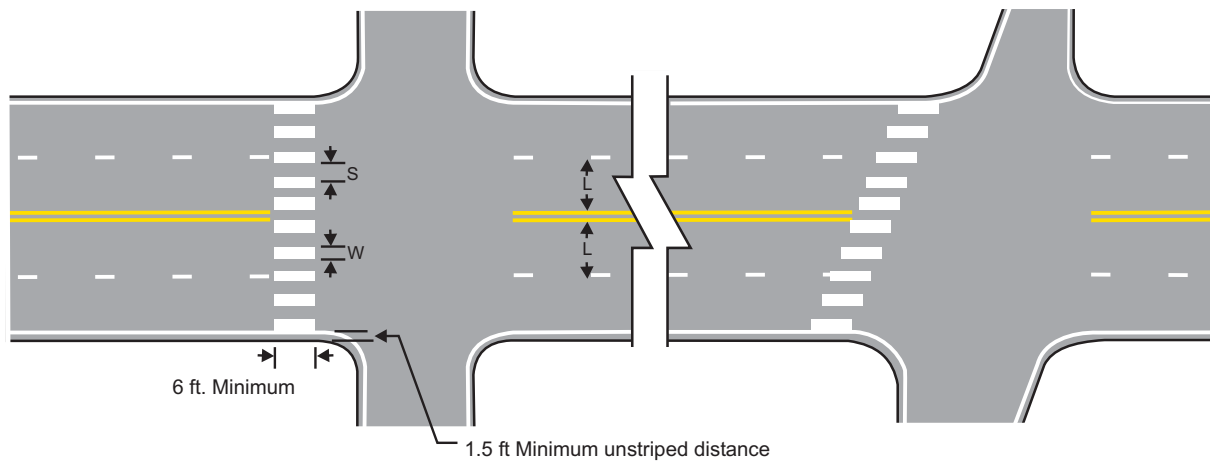

NOTES:

1. Painted areas to be centered on centerline and lane lines.
2. A minimum of 1.5 feet clear distance shall be left adjacent to the curb. If the last painted area falls into this distance, it must be omitted.
3. On two-lane, two-way streets, use the spacing shown for a 11 foot inside lane.
4. For divided roadways, adjustments in spacing of the blocks should be made in the median so that the blocks are maintained in their proper location across the traveled portion of the roadway.
5. At skewed crosswalks, the blocks are to remain parallel to the lane lines as shown.
6. The blocks shall be placed so that they are not located in the wheel path of the vehicles.

Text Ref.: 7-4.06.01

May 15, 2008

**PEDESTRIAN CROSSWALK MARKINGS -  
CONTINENTAL BLOCK DESIGN**

FIGURE  
**7.20**

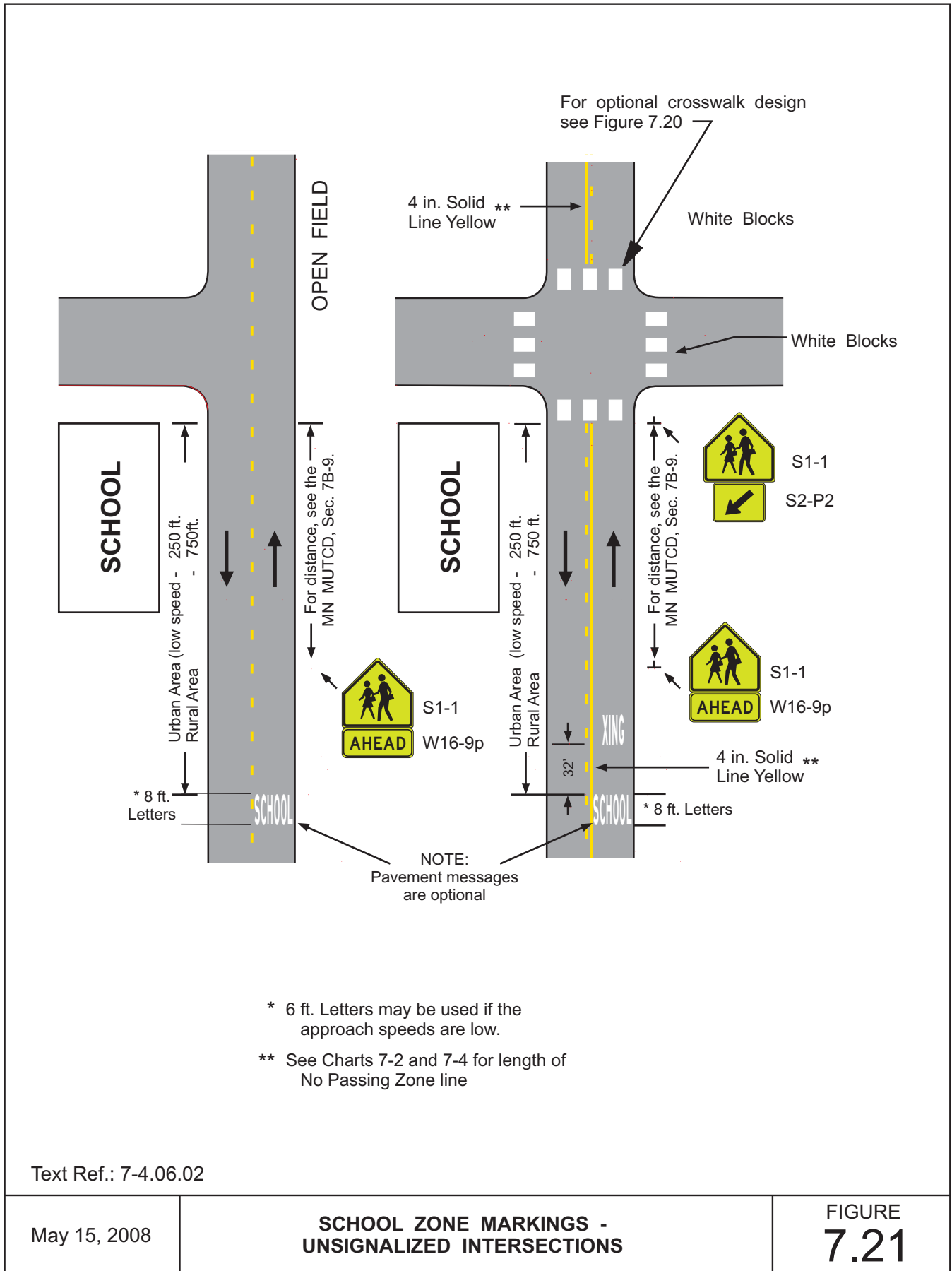

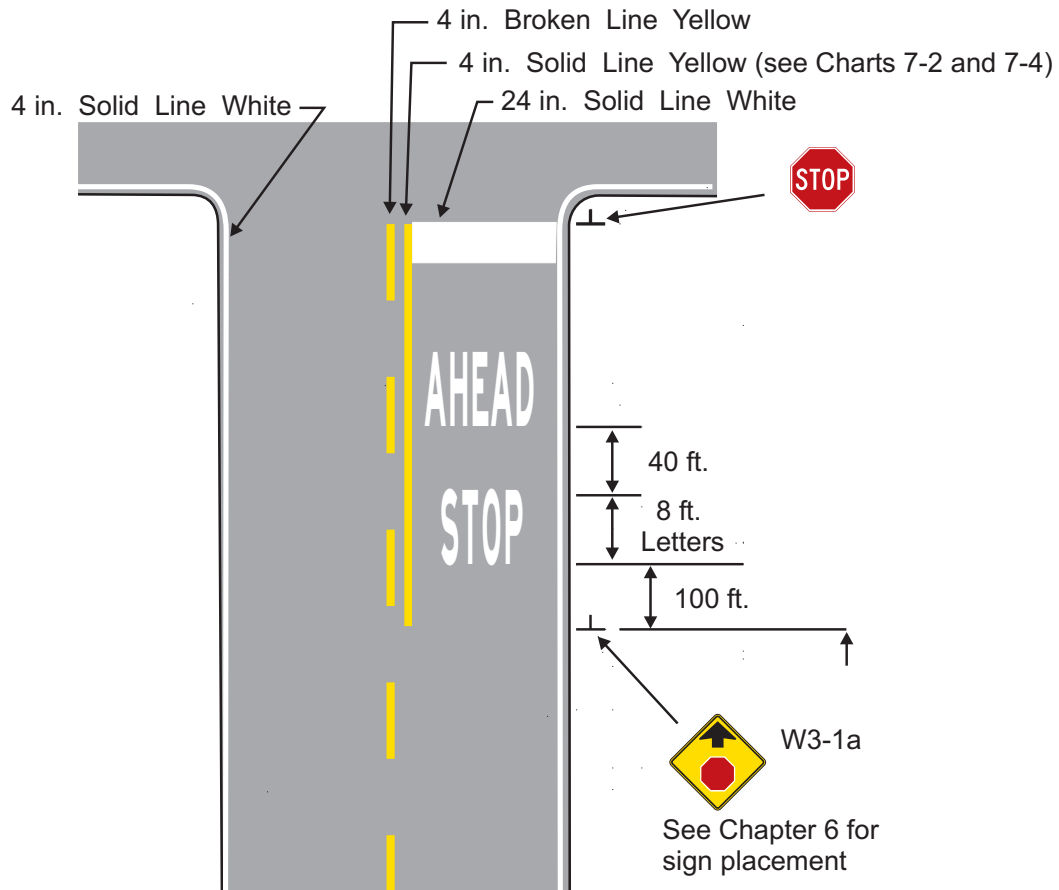

NOTES:

1. Do not install a STOP AHEAD pavement message if the intersection has adequate lighting.
2. Install only one set of STOP AHEAD pavement messages. If a Stop Ahead sign needs to be installed more than 1000 feet from the STOP sign, contact the district traffic engineer to determine if, and where, a second set of STOP AHEAD pavement messages should be installed.
3. The stop line should ordinarily be placed 4 feet in advance of and parallel to the nearest crosswalk line. In the absence of a marked crosswalk, the stop line should be placed at the desired stopping point, and in no case no more than 30 feet or less than four feet from the nearest edge of the intersecting curb line or the near edge of the thru lane.

If a stop line is used in conjunction with a stop sign, it should ordinarily be placed in line with the stop sign. However, if the sign cannot be located exactly where vehicles are expected to stop, the stop line should be placed at the stopping point.

Text Ref.: 7-4.06.04

May 15, 2008

**STOP AHEAD & STOP LINE  
PAVEMENT MARKINGS**

FIGURE  
**7.22**

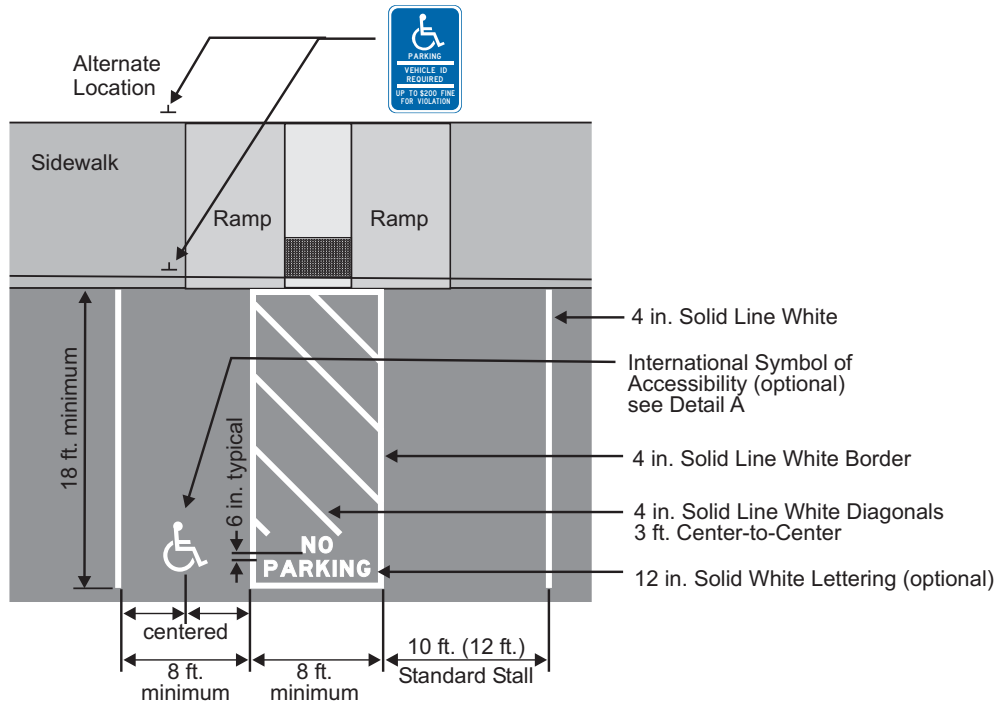

**SINGLE PARKING STALL**

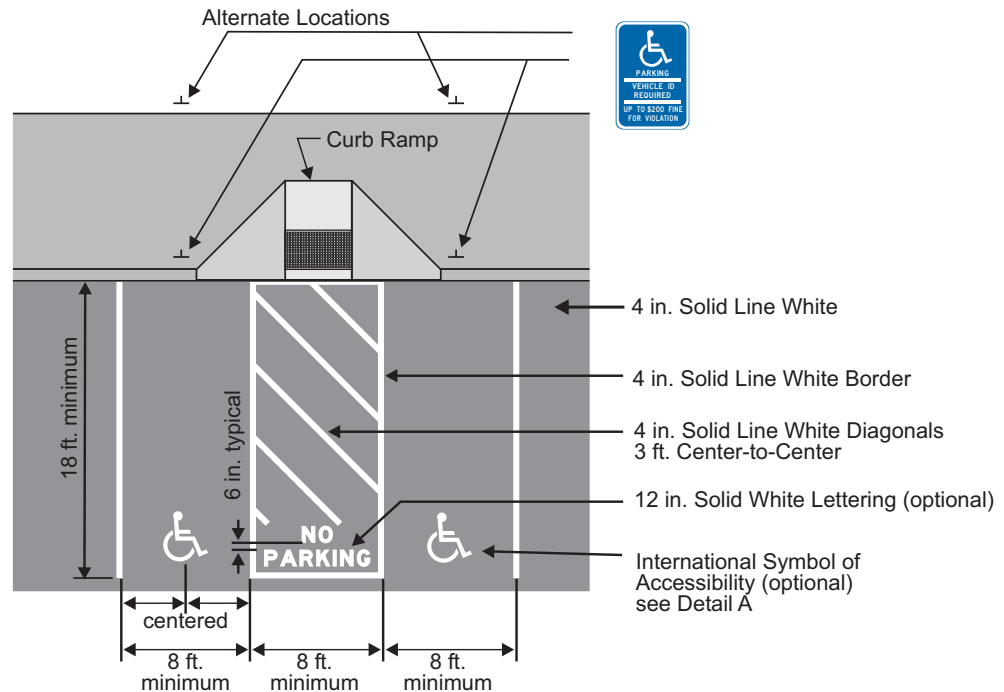

**DOUBLE PARKING STALL**

Text Ref.: 7-4.06.06

May 15, 2008

**PARKING AREA PAVEMENT MARKINGS  
DISABLED PARKING DETAILS**

**FIGURE  
7.23A**

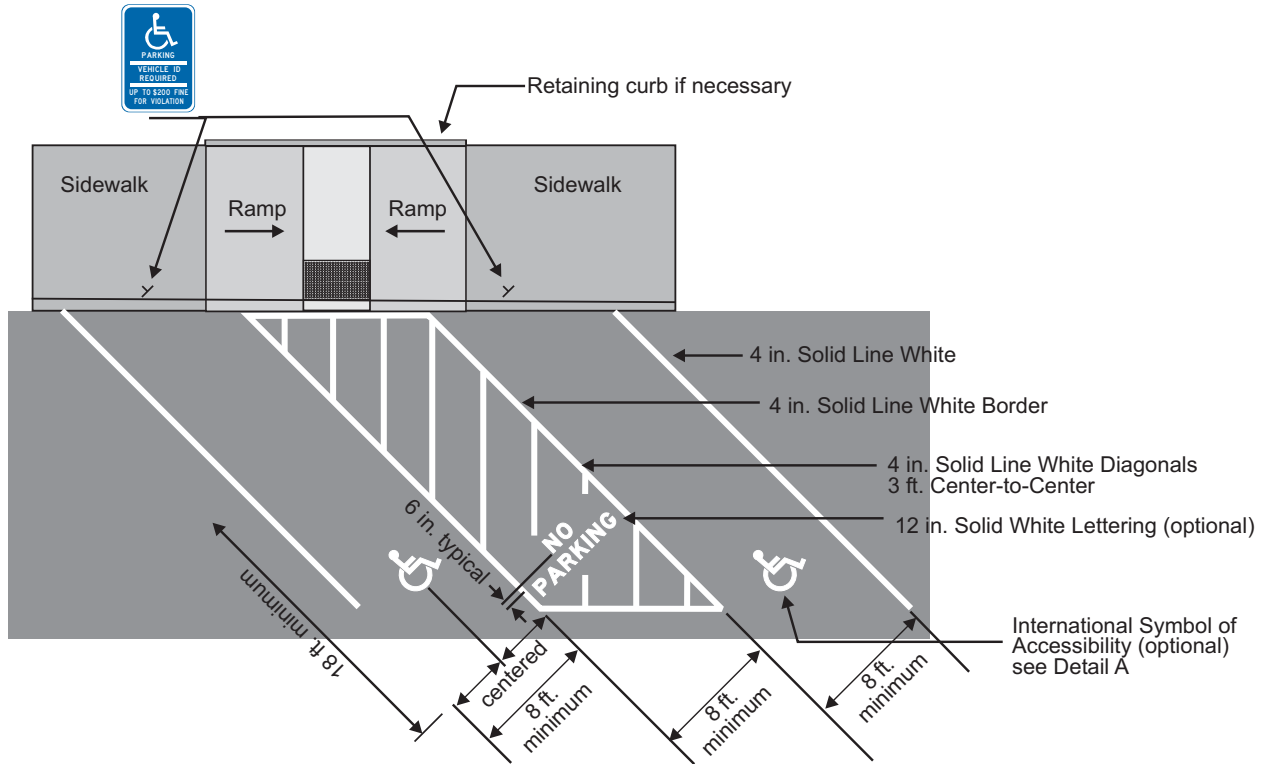

**DIAGONAL DOUBLE PARKING STALLS**

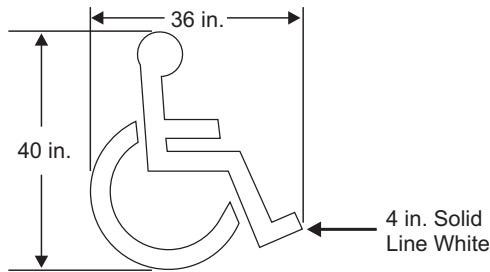

International Symbol of Accessibility Marking for accessible parking space or stall

**DETAIL A**

Total number of parking spaces or stalls	Minimum number of disabled accessible parking spaces or stalls
1 - 25	1
26 - 50	2
51 - 75	3
76 - 100	4
101 - 150	5
151 - 200	6
201 - 300	7
301 - 400	8
401 - 500	9
501 - 1000	2 percent of total
Greater than 1000	20 plus 1 for each 100 or fraction thereof over 1000

Text Ref.: 7-4.06.06

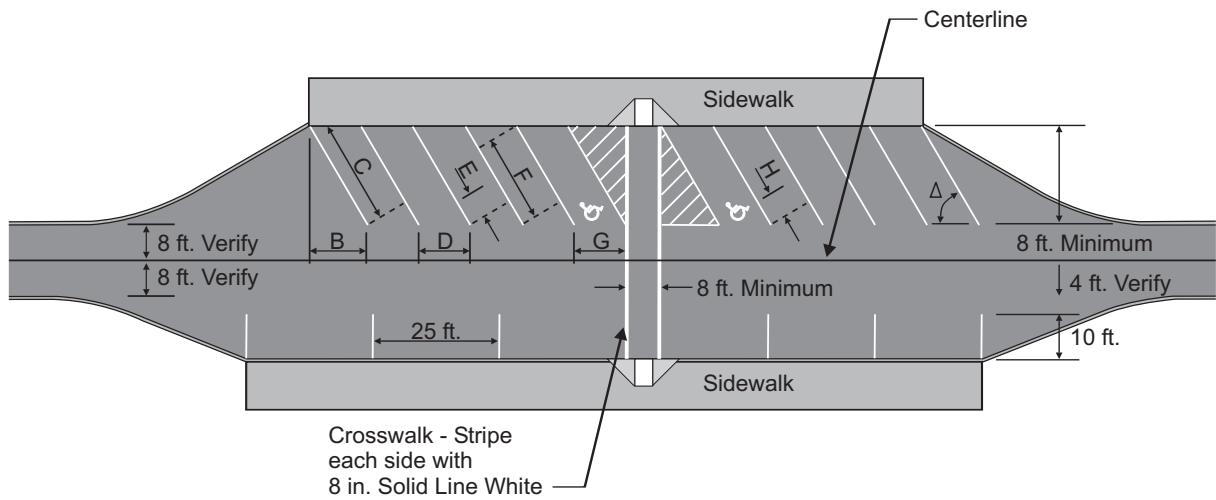

NOTES: When the parking area is located on a curve, the dimensions for the parking spaces should be adjusted (fanned) to compensate for curvature.  
 The location of the pedestrian curb ramp for the disabled will depend on the site development and landing location.

**Parking Space data (based on 18 ft. minimum stall length)**  
 (All dimensions are in feet or fractions of feet)

Δ	All stalls			10 ft wide stalls					12 ft wide stalls				
	A	B	C	D	E	F	G	H	D	E	F	G	H
45°	22.00	22.00	31.11	-	-	-	-	-	16.97	12.00	19.11	16.97	12.00
	20.00	20.00	28.28	14.14	10.00	18.28	14.14	10.00	-	-	-	-	-
50°	22.00	18.46	28.72	-	-	-	-	-	15.66	10.07	18.65	15.67	10.07
	21.00	17.62	28.41	13.05	8.39	19.02	13.05	8.39	-	-	-	-	-
55°	22.00	15.40	26.86	-	-	-	-	-	14.65	8.40	18.64	14.65	8.40
	21.00	14.70	25.64	12.21	7.00	18.64	12.21	7.00	-	-	-	-	-
60°	22.00	12.70	25.40	-	-	-	-	-	13.86	6.93	18.48	13.86	6.93
	21.00	12.12	24.25	11.55	5.77	18.48	11.55	5.77	-	-	-	-	-

Text Ref.: 7-4.06.06

May 15, 2008

**PARKING AREA PAVEMENT MARKINGS  
 PARKING STALL DETAILS**

**FIGURE  
 7.23C**



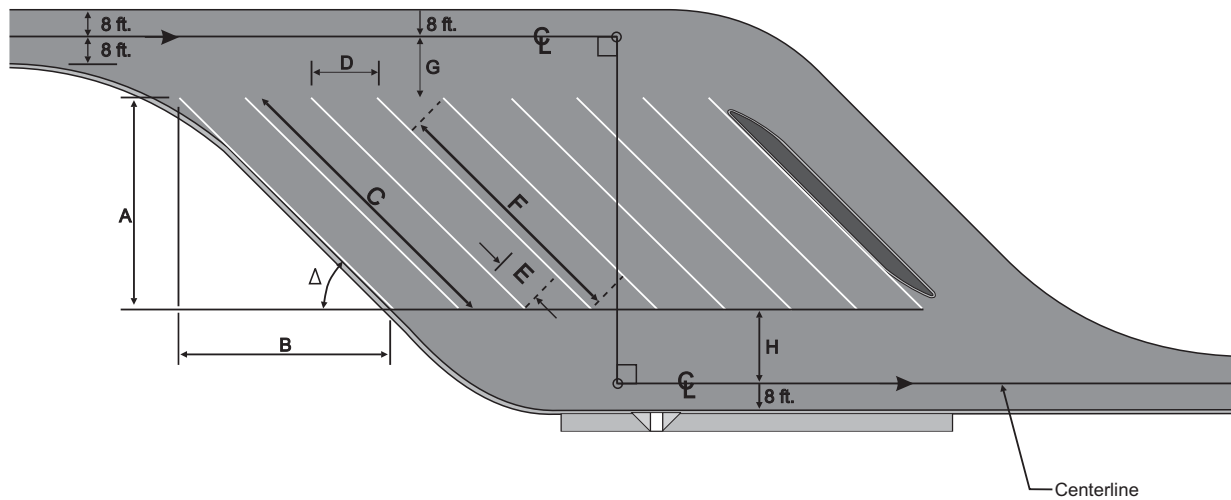

NOTES: When the parking area is located on a curve, the dimensions for the parking spaces should be adjusted (fanned) to compensate for curvature.  
 An island up to 14 ft. wide may be included between every ten stalls in the parking area.  
 The location of the pedestrian curb ramp for the disabled will depend on the site development and landing location.  
 The need for 150 ft. parking stalls should be studied on a case by case basis and additional parking provided for as may be required.

Parking Space data (based on 14 ft. x 75 ft. minimum stall length)  
 (All dimensions are in feet or fractions of feet)

Δ	A	B	C	D	E	F	G	H	℄ - ℄
30°	50.00	86.60	100.00	28.00	24.25	75.75	14.00	15.00	79.00
35°	55.00	78.55	95.89	24.41	20.00	75.90	19.00	18.00	92.00
40°	59.00	70.31	91.79	21.78	16.69	75.10	26.00	21.00	106.00
45°	63.00	63.00	89.10	19.80	14.00	75.10	32.00	25.00	120.00
50°	67.00	56.22	87.46	18.28	11.75	75.72	40.00	28.00	135.00
55°	70.00	49.01	85.45	17.09	9.80	75.65	46.00	31.00	147.00
60°	72.00	41.57	83.14	16.17	8.08	75.06	54.00	34.00	160.00

Text Ref.: 7-4.06.06

May 15, 2008

**PARKING AREA PAVEMENT MARKINGS  
 TRUCK PARKING STALL DETAILS**

**FIGURE  
 7.23D**

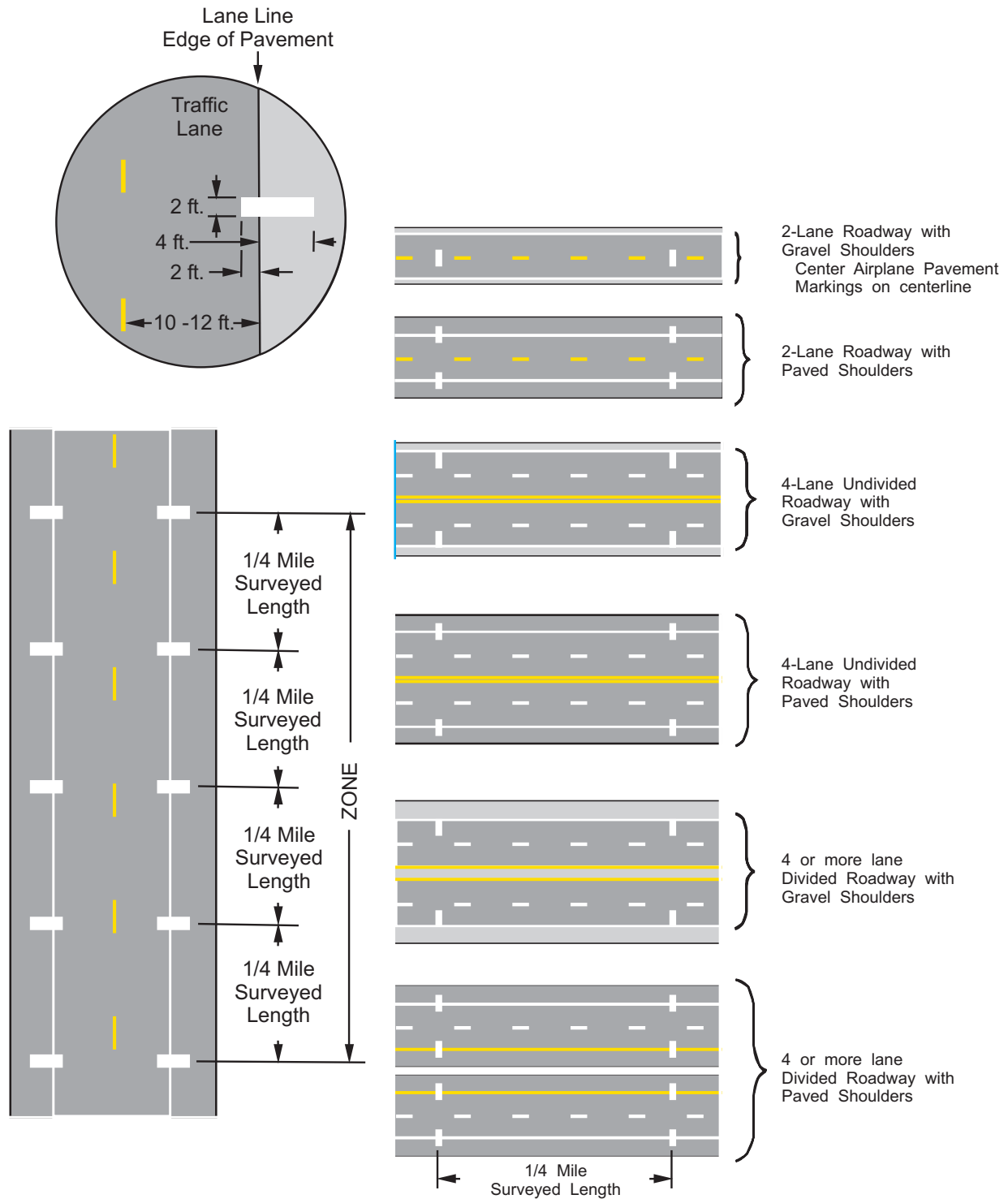

Text Ref.: 7-4.06.08

May 15, 2008

**AIRPLANE PAVEMENT MARKINGS**

**FIGURE  
7.24**

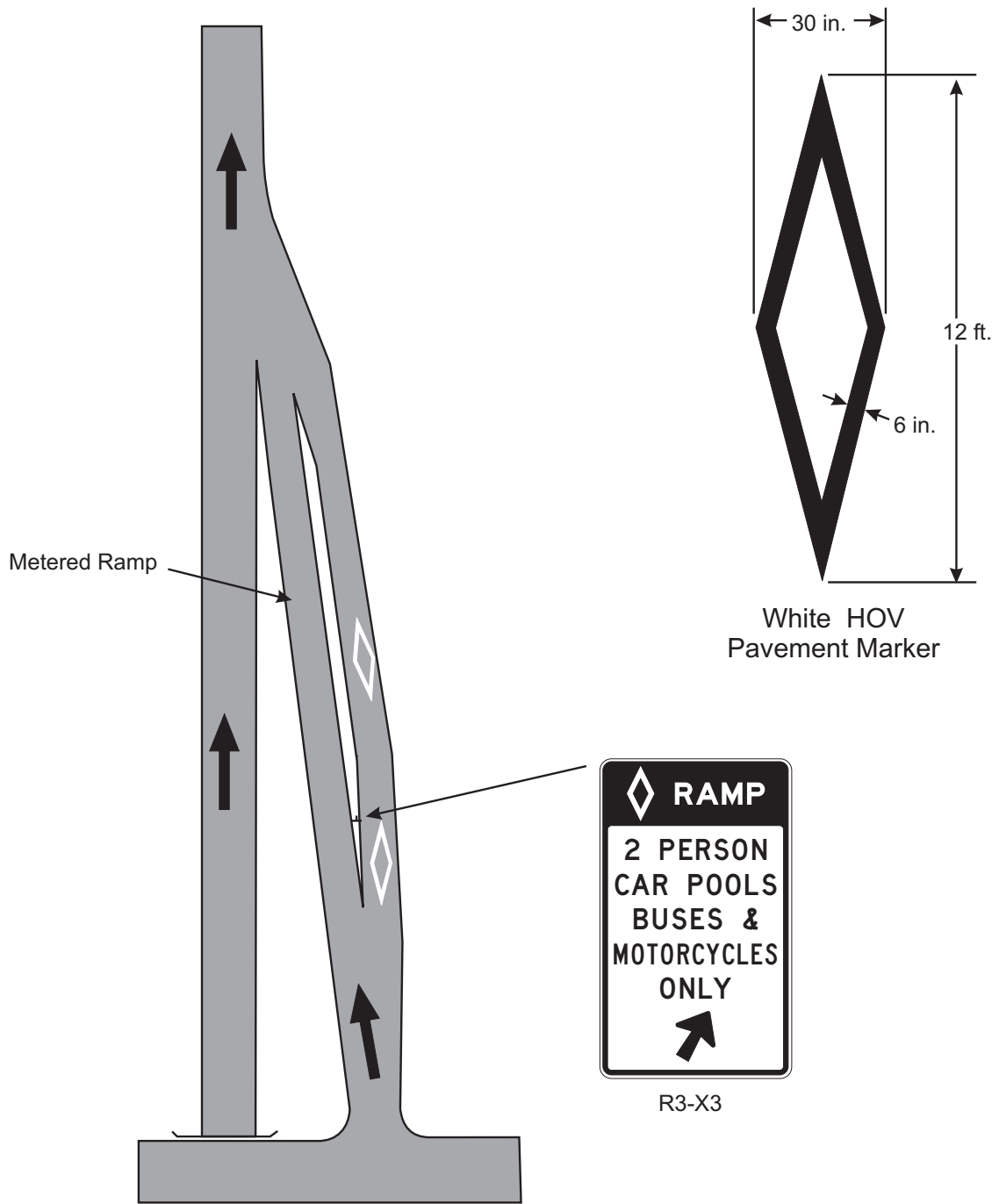

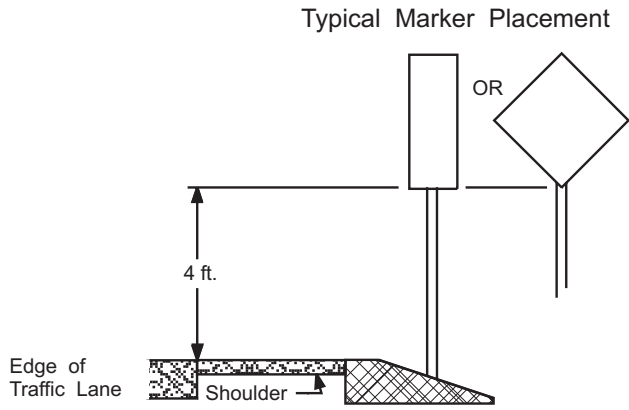

Cylinder Style Delineator X4-13

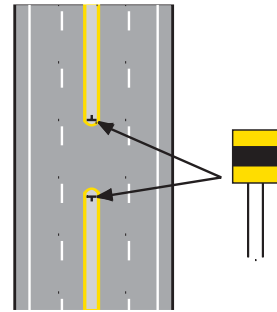

Clearance Marker X4-4 (R)

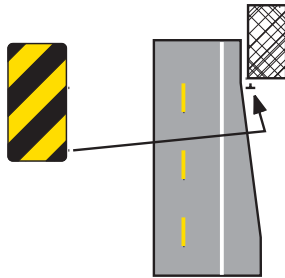

Use clearance marker to mark hazards adjacent to the roadway.

Hazard Marker X4-2

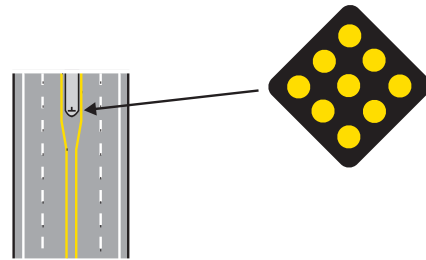

Use clearance marker to mark hazards within the roadway. See Figures 7.33 through 7.35 for typical application in gore areas of interchanges.

End of Roadway Marker X4-11

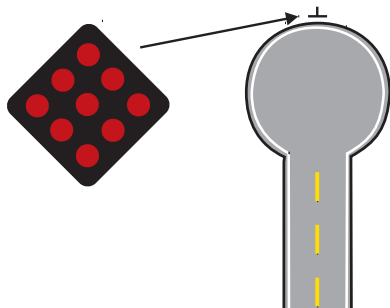

Use end of roadway marker to mark the end of the roadway.

Snowplow Marker X4-5

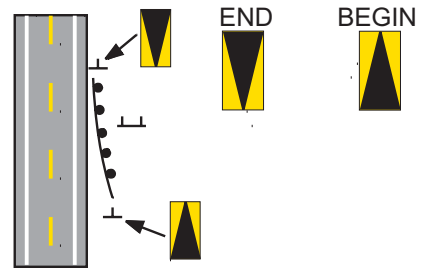

Use snowplow marker to mark guardrail for snowplowing operations.

Text Ref.: 7-5.02.01, 7-5.03.01, 7-5.03.05, and 7-5.03.06

May 15, 2008

COMMONLY USED OBJECT MARKERS

FIGURE  
7.26



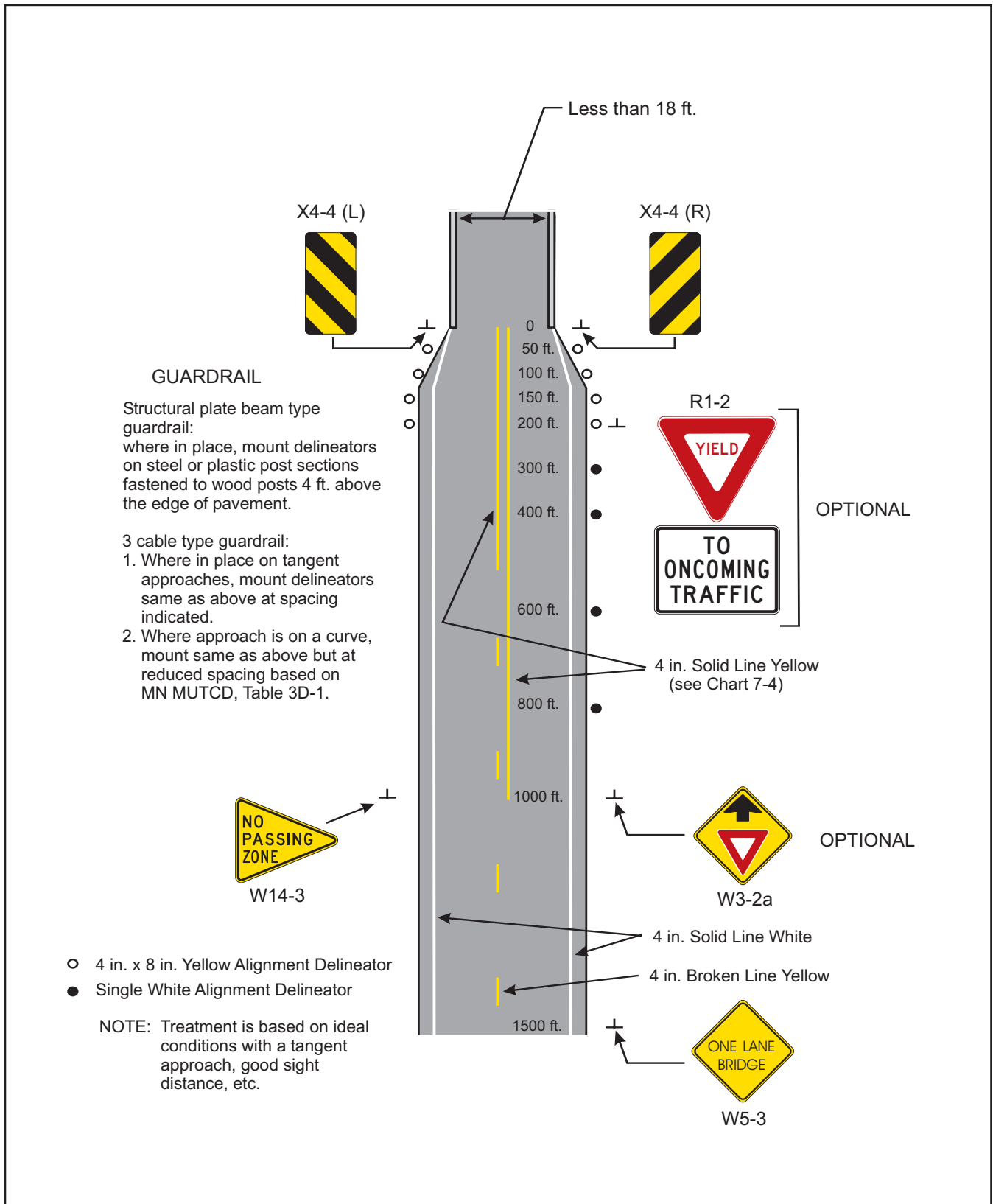

Text Ref.: 7-5.03.02

May 15, 2008

**ONE LANE BRIDGE SIGNING, MARKING & DELINEATION**

**FIGURE 7.28**

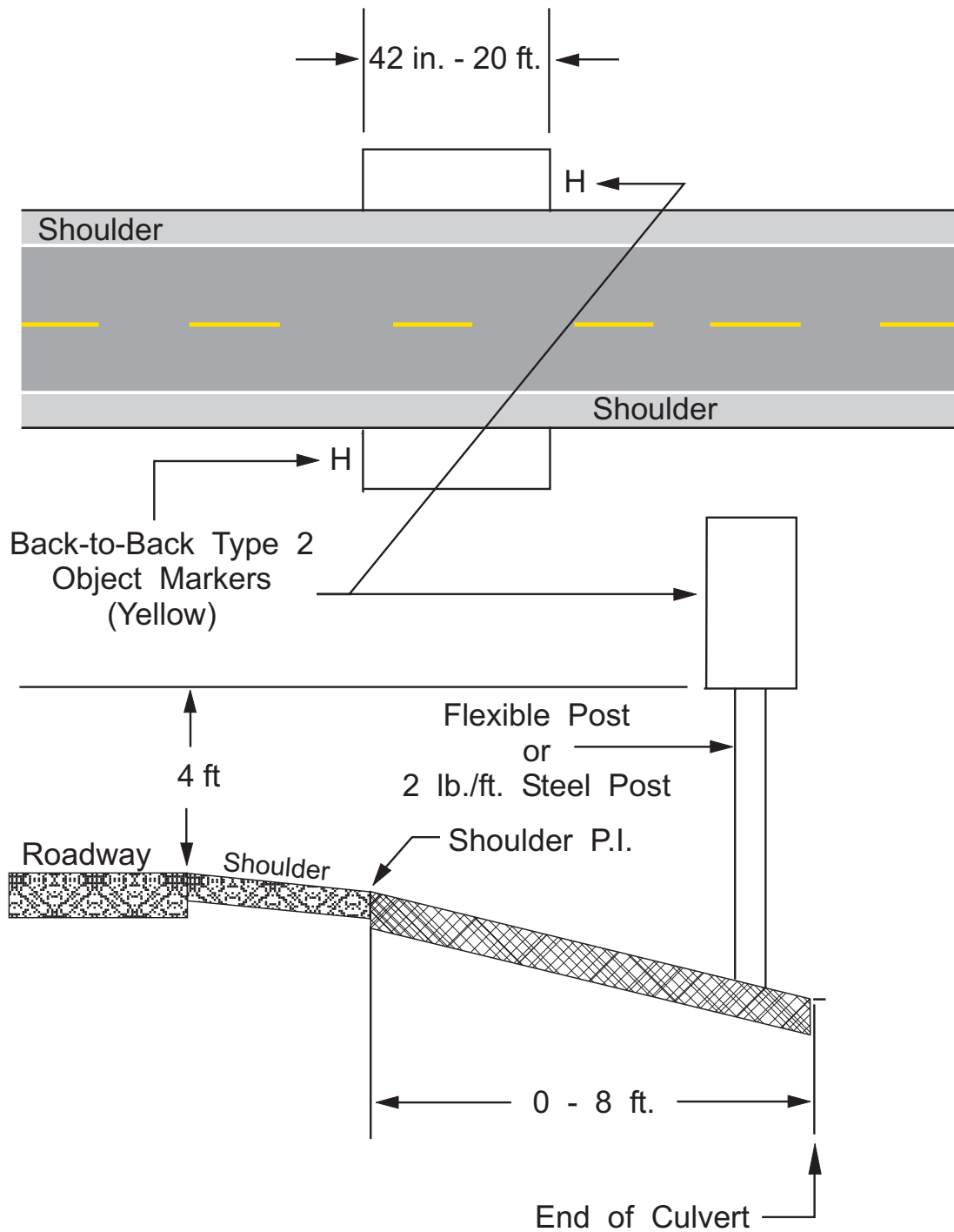

Text Ref.: 7-5.03.03

May 15, 2008

**UNPROTECTED LARGE CULVERT & CATTLEPASS MARKING**

**FIGURE 7.29**

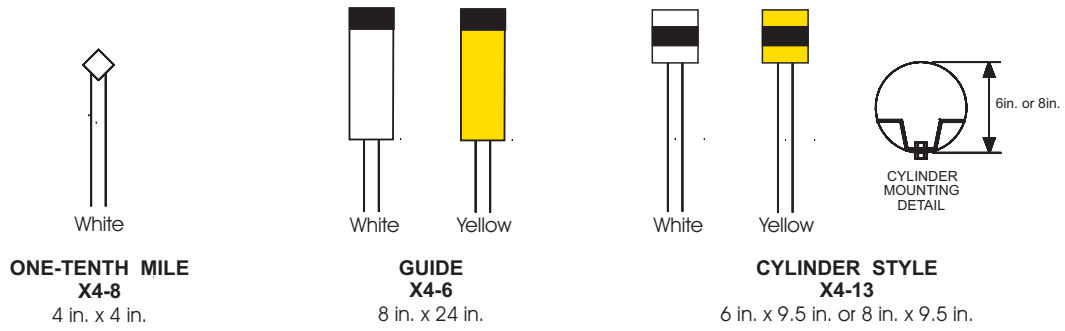

TYPES OF DELINEATORS

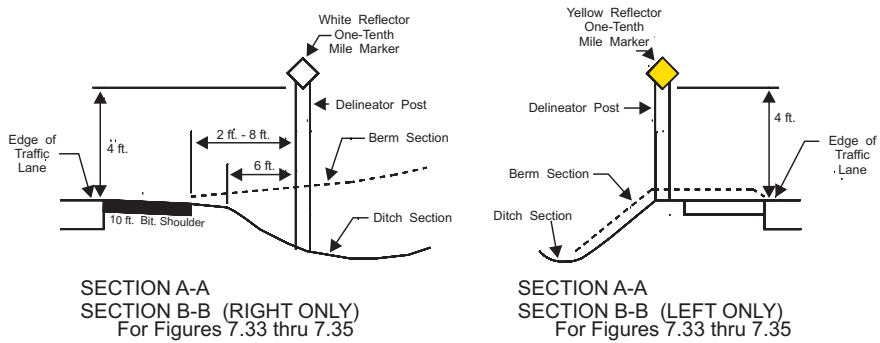

TYPICAL DELINEATOR PLACEMENT

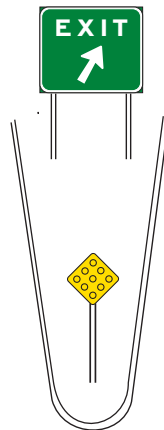

HAZARD MARKER AT EXIT GORE

Text Ref.: 7-5.03.05, 7.06.01, and 7-6.02.02

<p>May 15, 2008</p>	<p>DELINEATOR TYPES &amp; INSTALLATION</p>	<p>FIGURE 7.30</p>
---------------------	--	------------------------



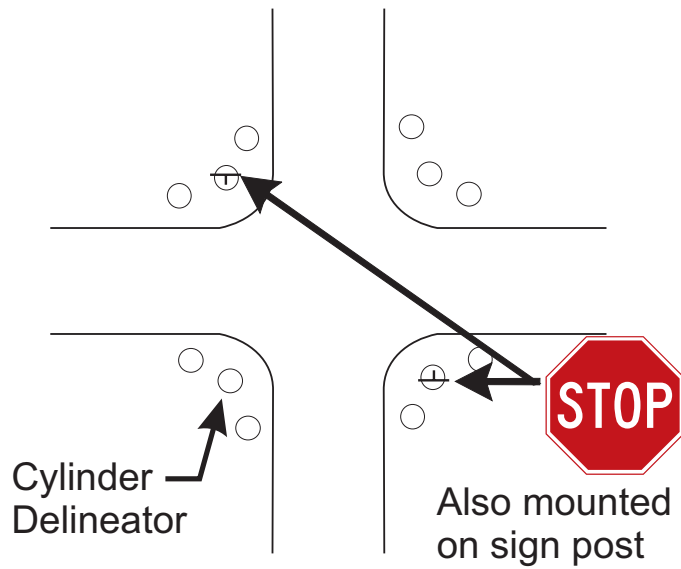
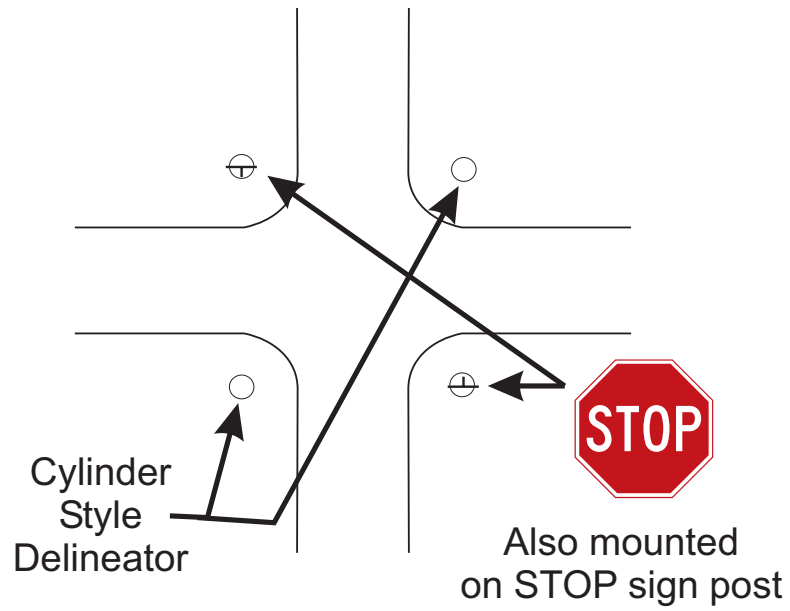

OPTIONAL LAYOUT

Text Ref.: 7-5.03.05, 7.06.01, and 7-6.02.02

May 15, 2008

DELINEATOR TYPES & INSTALLATION

FIGURE  
7.31

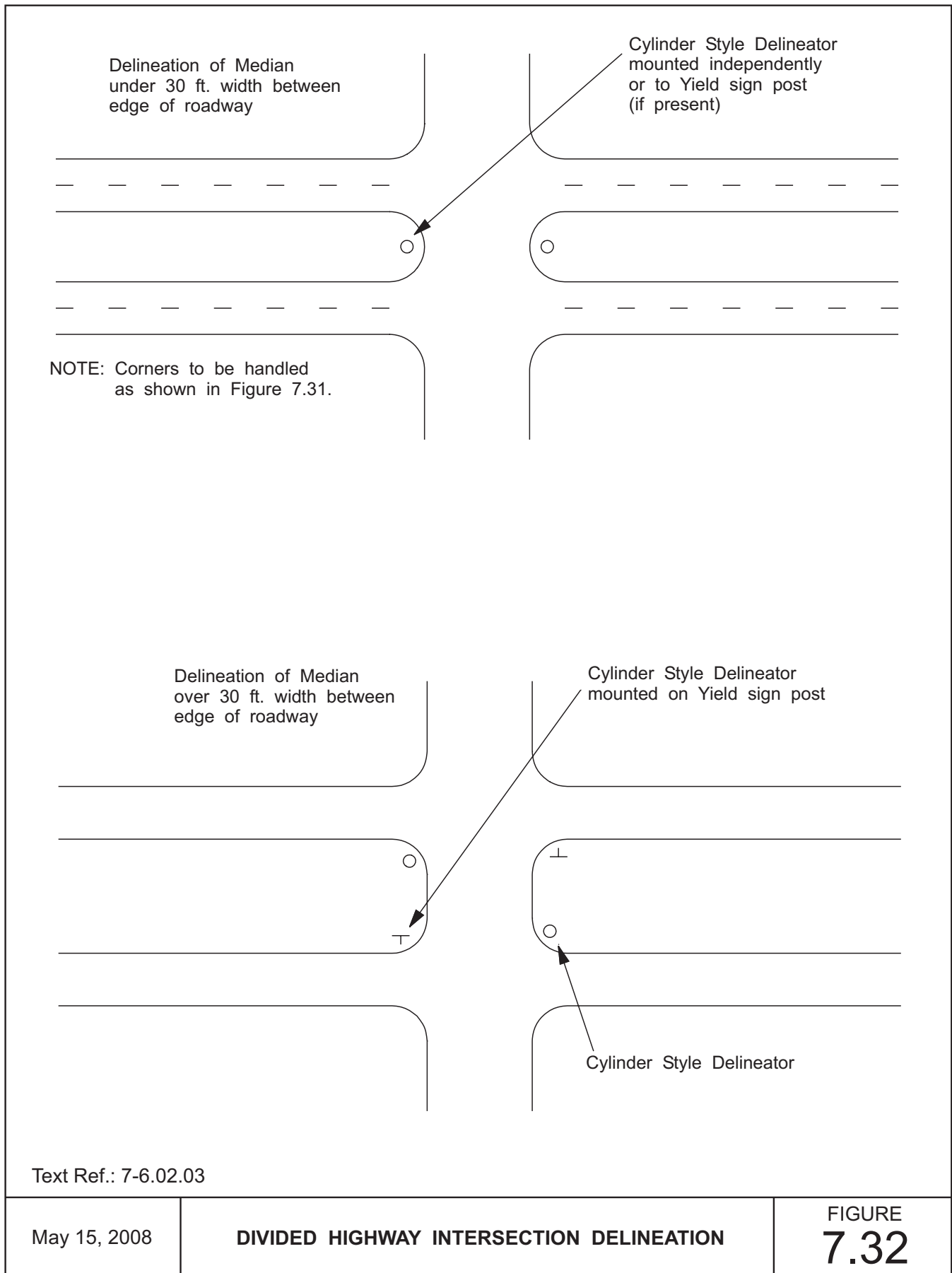

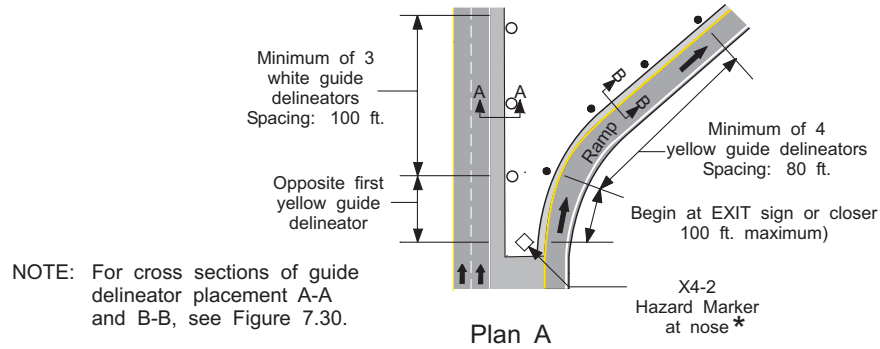

NOTE: For cross sections of guide delineator placement A-A and B-B, see Figure 7.30.

\* Optional if no hazard exists

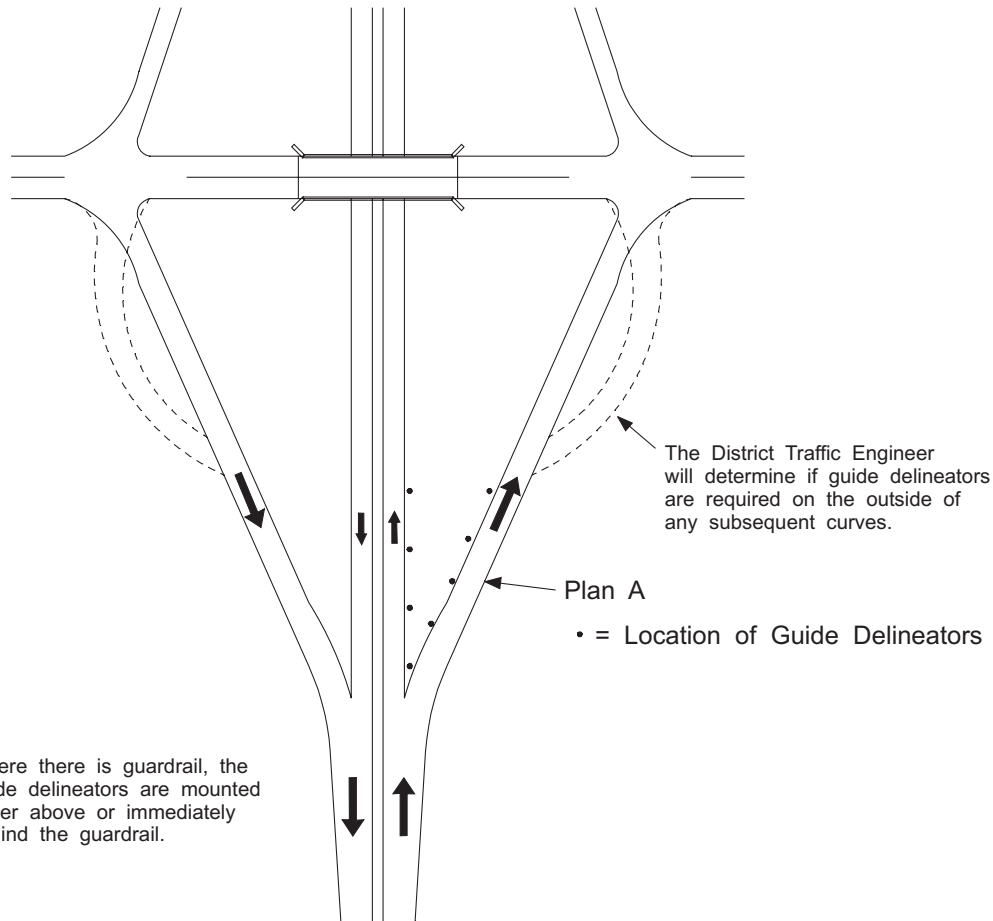

NOTE: Where there is guardrail, the guide delineators are mounted either above or immediately behind the guardrail.

Text Ref.: 7-6.02.04

May 15, 2008

DIAMOND INTERCHANGE DELINEATION - PARTIAL AND FULL LIGHTING

FIGURE 7.33

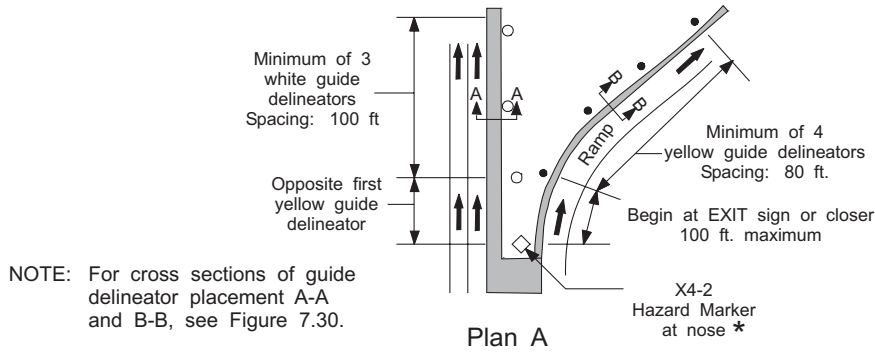

NOTE: For cross sections of guide delineator placement A-A and B-B, see Figure 7.30.

\*Optional if no hazard exists

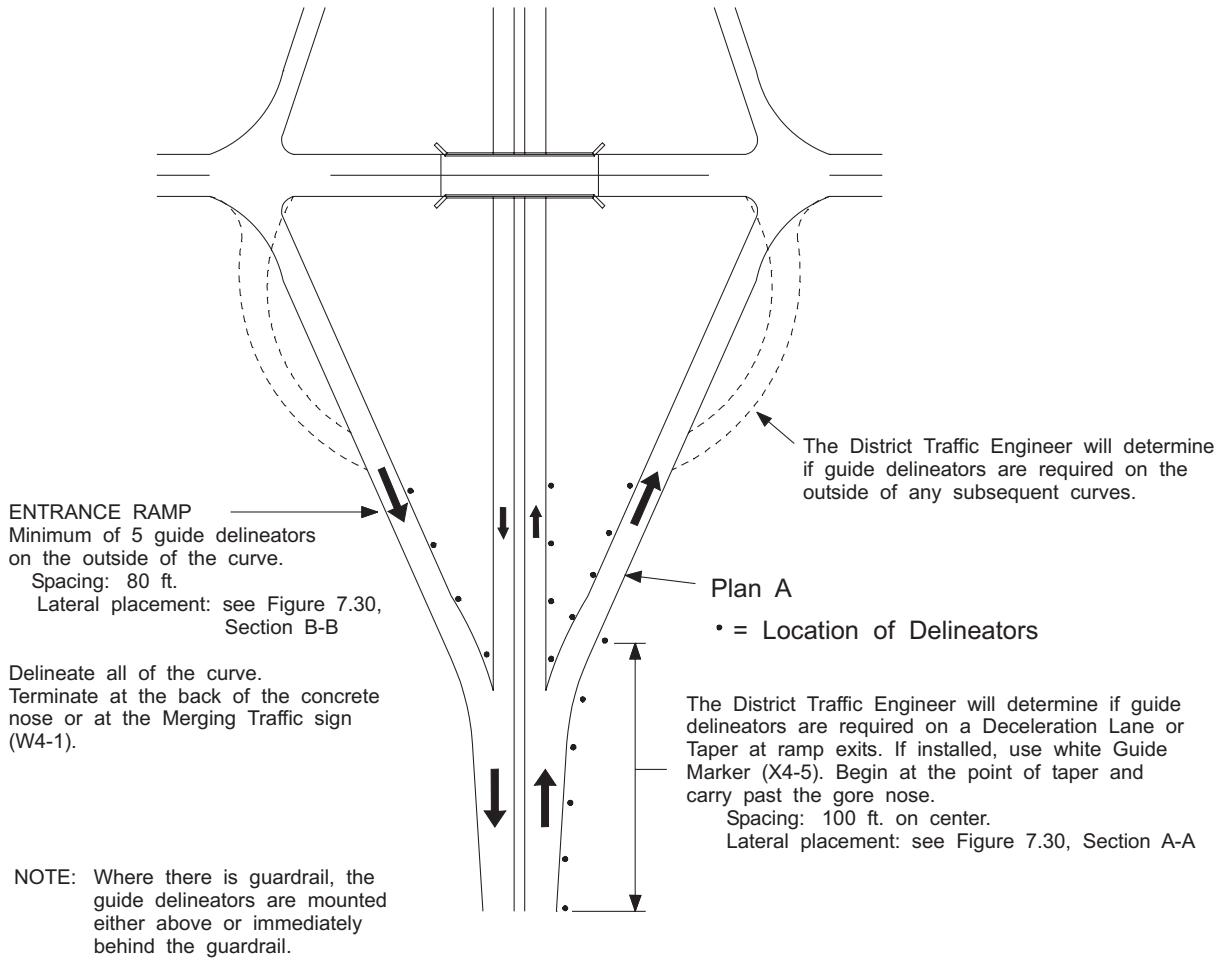

Text Ref.: 7-6.02.04

May 15, 2008

DIAMOND INTERCHANGE DELINEATION - UNLIT

FIGURE 7.34

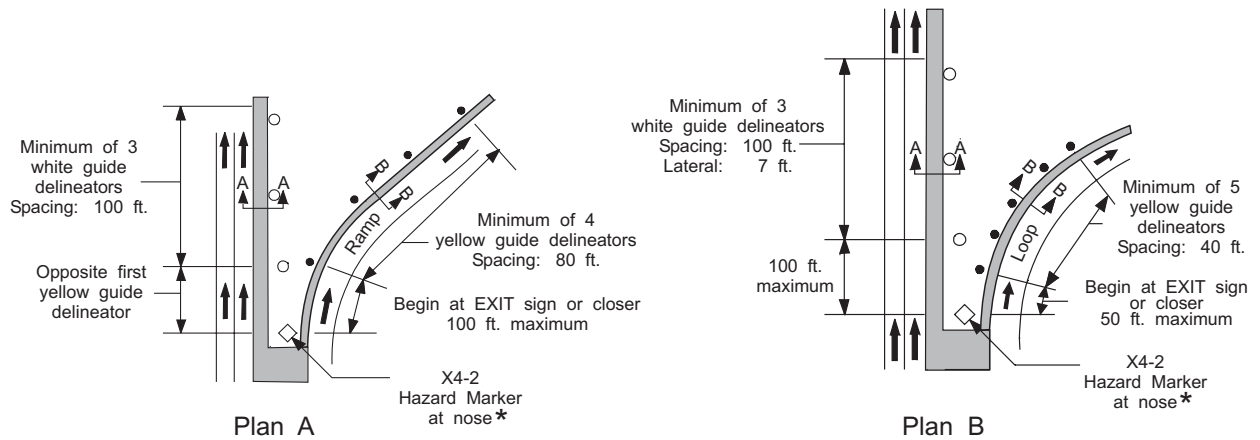

NOTE: For examples of cross sections A-A and B-B from Plan A and Plan B, see Figure 7.30.

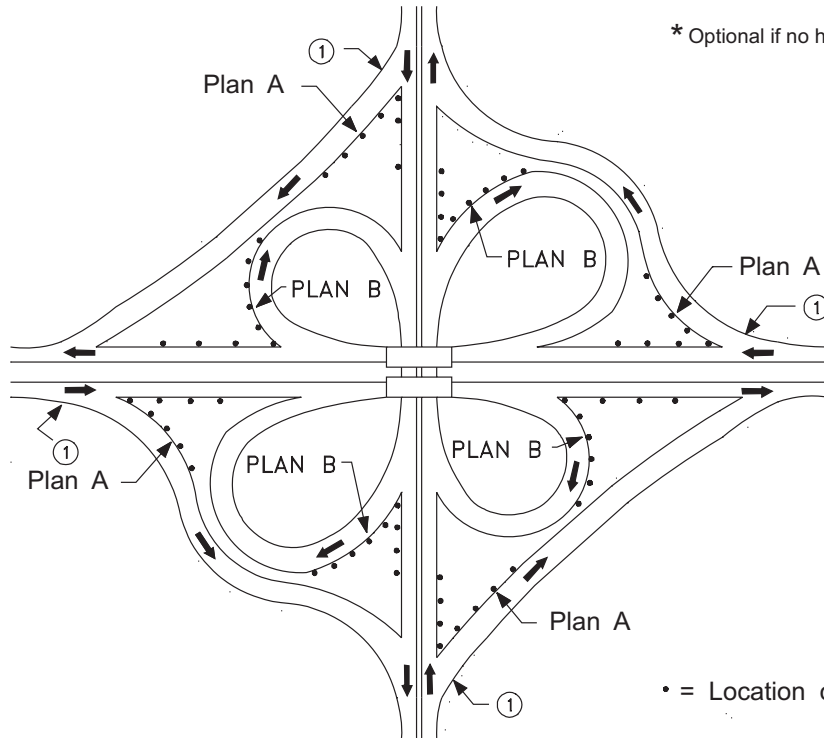

\* Optional if no hazard exists

• = Location of Guide Delineators

NOTE: Where there is guardrail, the guide delineators are mounted either above or immediately behind the guardrail.

① At unlit interchanges, the District Traffic Engineer will determine if guide delineators are required on a Deceleration Lane or Taper at ramp exits. If installed, use white Guide Delineator (X4-5). Begin at the point of taper and carry past the gore nose. Spacing: 100 ft. on center. Lateral placement: see Figure 7.30, Section A-A

Text Ref.: 7-6.02.04

May 15, 2008	<b>CLOVERLEAF INTERCHANGE DELINEATION - FULL LIGHTING</b>	<b>FIGURE 7.35</b>
--------------	---	--------------------

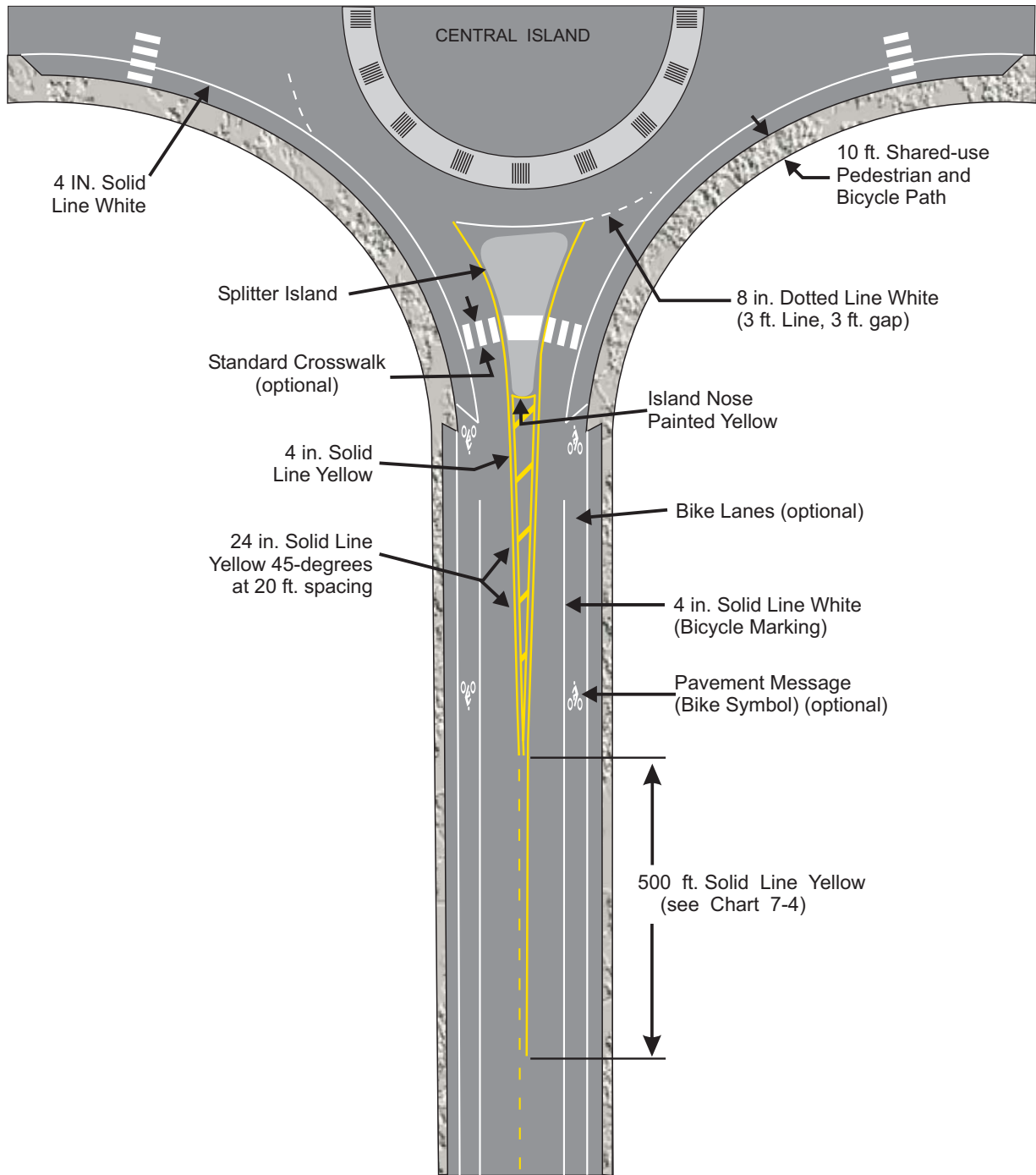

Text Ref.: 7-4.06.10

October 31, 2009	<b>ROUNDABOUT INTERSECTION PAVEMENT MARKINGS</b>	<b>FIGURE 7.36</b>
------------------	--	------------------------

	Speed Limit (or 85th Percentile) MPH	Minimum Length	
		Feet	Yards
	0 - 30	300	100
	40 - 50	400	133
	55 or greater	500	167

Text Ref.: 7-4.04.01

May 15, 2008	<b>MINIMUM LENGTH OF A NO PASSING ZONE IN ADVANCE OF A STOP CONDITION</b>	CHART <b>7-2</b>
--------------	---	---------------------

	85th Percentile Speed MPH	Minimum Sight Distance	
		Feet	Yards
	30 or less	500	167
	31-40	600	200
	41-50	800	267
	51-60	1,000	333
	61 or greater	1,100	367

Text Ref.: 7-4.04.01

May 15, 2008	<b>MINIMUM PASSING SIGHT DISTANCE</b>	CHART <b>7-3</b>
--------------	---------------------------------------	---------------------



	85th Percentile Speed MPH	Distance Between Zones	
		Feet	Yards
	20-39	500	167
	40-54	650	217
	55 and above	800	267

If the distance between zones is less than specified,  
the zones should be connected.

Text Ref.: 7-4.04.01

May 15, 2008	<b>MINIMUM DISTANCE OR GAP BETWEEN NO PASSING ZONES</b>	CHART <b>7-4</b>
--------------	---	---------------------

### Wide Angle VIP Retroreflective Sheeting (TYPE IX)

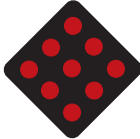
NAME	OBJECT MARKER	SIZE	COLOR	INFORMATION SEE MN MUTCD
Hazard Marker Type 1 (X4-2)		18" x 18"	All Yellow or Yellow on Black	Section 3C-3
Culvert Marker Type 2 (X4-3)	 (vert. or horz.)	6" x 12"	Yellow on White or All Yellow	Section 3C-3
Clearance Marker Type 3 (X4-4)	 (left or right)	12" x 36" 18" x 36"	Black on Yellow	Section 3C-3
End of Roadway Marker (X4-11)		18" x 18"	All Red or Red on Black	Section 3C-4

### Encapsulated Retroreflective Sheeting - (Type III)

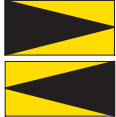
Snowplow Marker (X4-5)		6" x 12"	Black on Yellow	None
------------------------	---	----------	-----------------	------

Text Ref.: 7-5.02.01



May 15, 2008

**OBJECT MARKERS**

CHART  
**7-5**

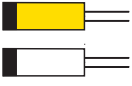

# Wide Angle VIP Retroreflective Sheeting (TYPE IX)

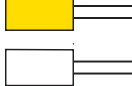
NAME	DELINEATOR	SIZE	COLOR	INFORMATION SEE MN MUTCD
One Tenth Mile Delineator (X4-8)		4" x 4"	White	Section 2D-46
Guide Delineator (X4-6)		8" x 24"	Black top on White or Yellow	None
Chevron Alignment Sign (W1-8)		18" x 24"	Black on Yellow	Section 2C-10
Alignment Delineator (X4-7)		4" x 8"	White or Yellow	None

# Type VII MD Retroreflective Sheeting

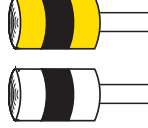
Cylinder Style Delineator (X4-13)		6" or 8" Diameter 9.5" Height	White or Yellow	Section 3D-4.5
-----------------------------------	---	----------------------------------	-----------------	----------------

Text Ref.: 7-5.04

May 15, 2008

**DELINEATOR FABRICATION DETAILS**

CHART  
**7-6**

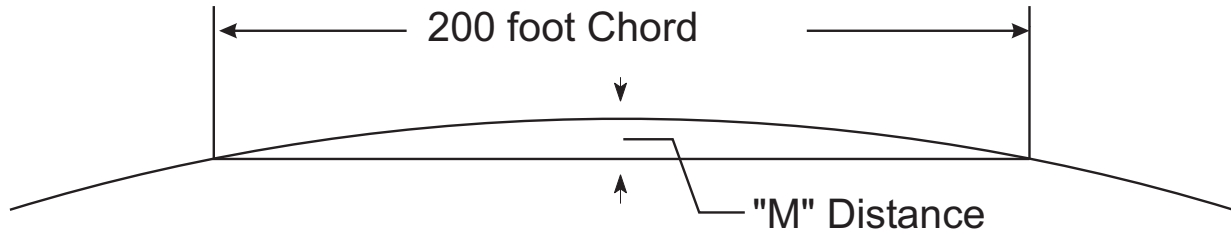

Take 200 foot tape, chain, or rope and stretch it between two points on a curve. At the center (100 foot mark), measure the distance in feet and inches between the chord and the arc.

DEGREE OF CURVE RELATED TO "M" FOR A 200 FOOT CHORD

Degree of Curve	Distance "M" feet	Distance "M" inches	Radius feet
0°30'	0.44	5-1/2	
1°00'	0.87	10-1/2	5,730
1°30'	1.31	15-3/4	3,820
2°00'	1.75	21	2,865
2°30'	2.18	26	2,292
3°00'	2.62	31-1/2	1,910
3°30'	3.06	36-3/4	1,637
4°00'	3.96	42	1,432
4°30'	3.49	47-1/2	1,273
5°00'	3.93	52-1/2	1,146
5°30'	4.37	57-3/4	1,042
6°00'	4.81	63	955
6°30'	5.25	68-3/8	881
7°00'	5.69	73-5/8	819
7°30'	6.13	78-7/8	764
8°00'	6.57	84-1/4	716
8°30'	7.02	89-1/2	674
9°00'	7.46	94-3/4	637
9°30'	7.90	100-1/4	603
10°00'	8.35	105-1/5	573

Text Ref.: 7-6.02.02

May 15, 2008

FINDING THE DEGREE OF CURVE  
FOR A HORIZONTAL CURVE

CHART  
7-7

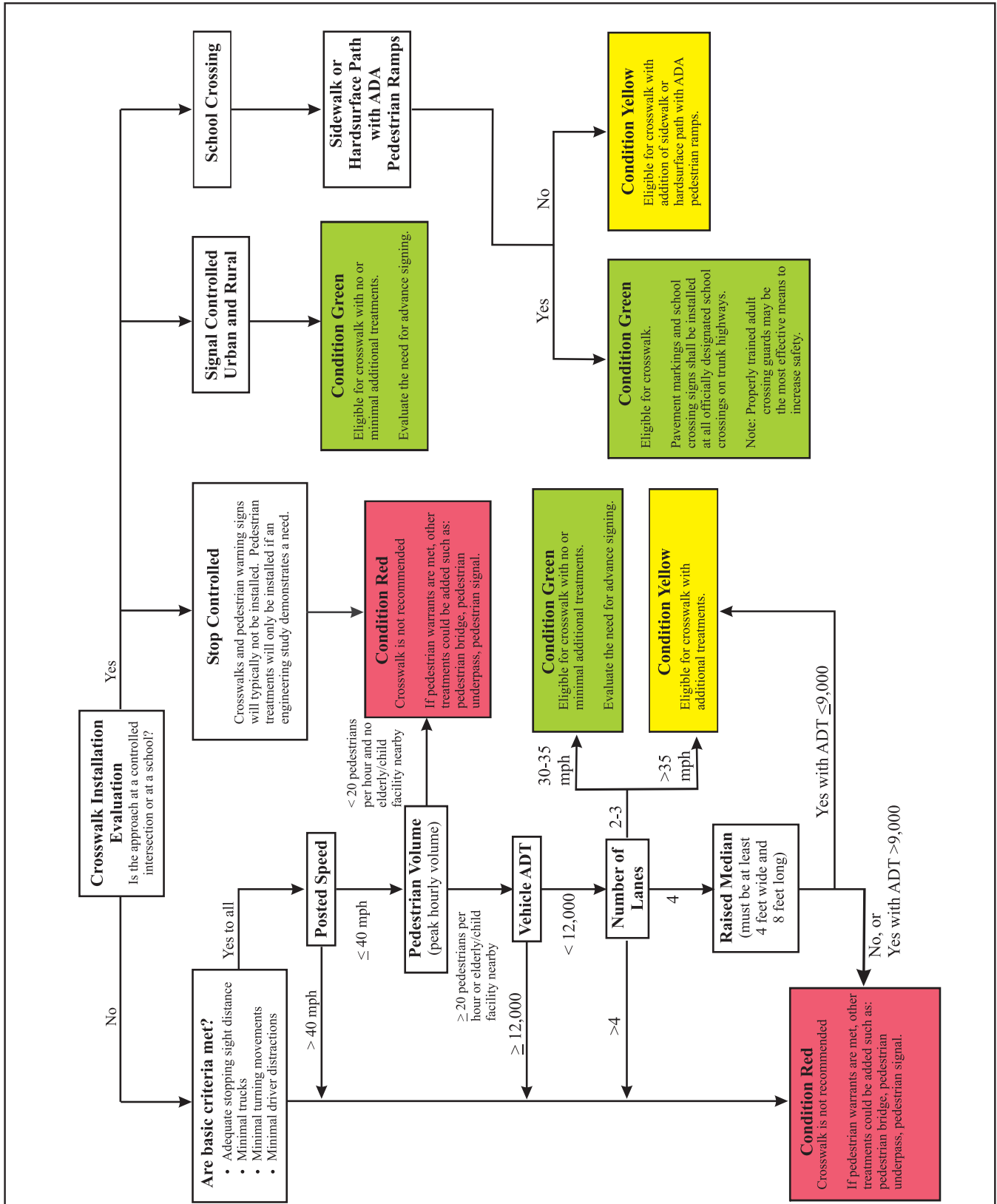

Text Ref.: 7-6.02.02

<p>May 15, 2008</p>	<p><b>CROSSWALK WARRANTS</b></p>	<p>CHART <b>7-8</b></p>
---------------------	----------------------------------	-----------------------------

